

NELES® ND9000 INTELLIGENT VALVE CONTROLLER

Metso's Neles ND9000 is a top class intelligent valve controller designed to operate on all control valve actuators and in all industry areas. It guarantees end product quality in all operating conditions with unique diagnostics and incomparable performance features. ND9000 is a reliable and future-proof investment with life-time support.

KEY FEATURES

- Benchmark control performance on rotary and linear valves
- Reliable and robust design
- Easy commissioning and operation
- Safety; IEC 61508 compliant up to and including SIL 2 by TUV
- Language selection: English, German and French
- Local / remote operation
- Expandable architecture
- Advanced device diagnostics including
 - Self-diagnostics
 - Online diagnostics
 - Performance diagnostics
 - Communication diagnostics
 - Extended off-line tests
 - Performance view
 - Online Valve Signature

Options

- Interchangeable communication options:
 - HART 6 or 7 (H)
 - FOUNDATION fieldbus
 - Profibus PA
- Limit switches
- Position transmitter (in HART only)
- Full stainless steel enclosure
- Exhaust adapter
- Remote mounting
- Arctic version (up to -53 °C / -64 °F)

Total cost of ownership

- Low energy and air consumption
- Future proof design allows further options at a reduced cost
- Optimized spares program minimizes spare part inventory
- Retro-fit to existing installations (Neles or 3rd party valves)

Minimized process variability

- Linearisation of the valve flow characteristics
- Excellent dynamic and static control performance
- Fast response to control signal change
- Accurate internal measurements



Easy installation and configuration

- Same device can be used for linear and rotary valves, double and single-acting actuators
- Simple fast calibration and configuration
 - using Local User Interface (LUI)
 - using DTM / EDD in a remote location
 - using Distributed Control System (DCS) asset management tools
- Extensive selection of mounting kits for 3rd party actuators
- Low power consumption enables installation to all common control systems

Open solution

- Metso is committed to delivering products that freely interface with software and hardware from a variety of manufacturers; ND9000 is no exception. This open architecture allows the ND9000 to be integrated with other field devices to give an unprecedented level of controllability.
- FDT and EDD based multi-vendor support configuration
- Support files for ND9000 are available from our internet pages, at www.metso.com/valves - choose the link: download center

Neles ND9000 in fieldbus networks

- Approved interoperability
 - Host interoperability ensured
 - FOUNDATION fieldbus ITK version 6.1.2 certified
 - Profibus PA profile version 3.0 PNO certified
- Easy to upgrade; by replacing the HART communication board with a fieldbus communication board
- Excellent maintainability with firmware download feature
- Advanced communication diagnostics
- Digital communication via the fieldbus includes not only the set point, but also the position feedback signal from the position sensor. No special supplementary modules for analog or digital position feedback are needed when using the fieldbus valve controller.
- Back up LAS functionality available in FOUNDATION fieldbus environment
- Input selector and output splitter blocks available in FOUNDATION fieldbus devices allowing advanced distributed control
- Standard function blocks enables the freedom to use the ND9000 intelligent valve controller in either continuous or on-off control applications
- Open and close information is directly available via the fieldbus
- Open and close detection is based on either position measurement (soft limit switch) or mechanical limit switch information

ND9000 mounting on actuators and valves

- Mounted on single and double acting actuators
- Both rotary and linear valves
- Ability to attach options to electronics and mechanics later
- 1-point calibration feature enables mounting without disturbing the process

Product reliability

- Designed to operate in harsh environmental conditions
- Rugged modular design
- Excellent temperature characteristics
- Vibration and impact tolerant
- IP66 enclosure
- Stainless steel enclosure (ND9300 and ND9400)
- Protected against humidity
- Maintenance free operation
- Resistant to dirty air
- Wear resistant and sealed components
- Contactless position measurement

Predictive maintenance

- Easy access to collected data with Metso DTM
- Unique Online Valve Signature to detect valve friction even more accurately.
- Performance view with report, which gives guidelines for recommended actions.
- Logical trend and histogram collection
- Information collected during process uptime
- Extensive set of off-line tests with accurate key figure calculations
- Fast notifications with on-line alarms
- Condition monitoring tool available
- Real time monitoring of valve control parameters

TECHNICAL DESCRIPTION

The ND9000 is a 4–20 mA or fieldbus powered microcontroller-based intelligent valve controller. The device contains a Local User Interface (LUI) enabling local configuration. A PC with FDT/DTM software can be connected to the ND9000 itself or to the control loop.

The powerful 32-bit microcontroller controls the valve position. The measurements include:

- Input signal
- Valve position with contactless sensor
- Actuator pressures, 2 independent measurements
- Supply pressure
- Spool valve position
- Device temperature

Advanced self-diagnostics guarantees that all measurements operate correctly. After connections of electric signal and pneumatic supply, the micro controller (μC) reads the input signal, position sensor (α), pressure sensors (P_s , P_1 , P_2) and spool position sensor (SPS). A difference between input signal and position sensor (α) measurement is detected by control algorithm inside the μC . The μC calculates a new value for prestage (PR) coil current based on the information from the input signal and from the sensors. The changed current to the PR changes the pilot pressure to the spool valve. Reduced pilot pressure moves the spool and the actuator pressures change accordingly. The spool opens the flow to the driving side of the double diaphragm actuator and opens the flow out from the other side of the actuator. The increasing pressure will move the diaphragm piston. The actuator and feedback shaft rotate. The position sensor (α) measures the rotation for the μC . The μC using control algorithm modulates the PR-current from the steady state value until the new position of the actuator, according to the input signal, is reached.

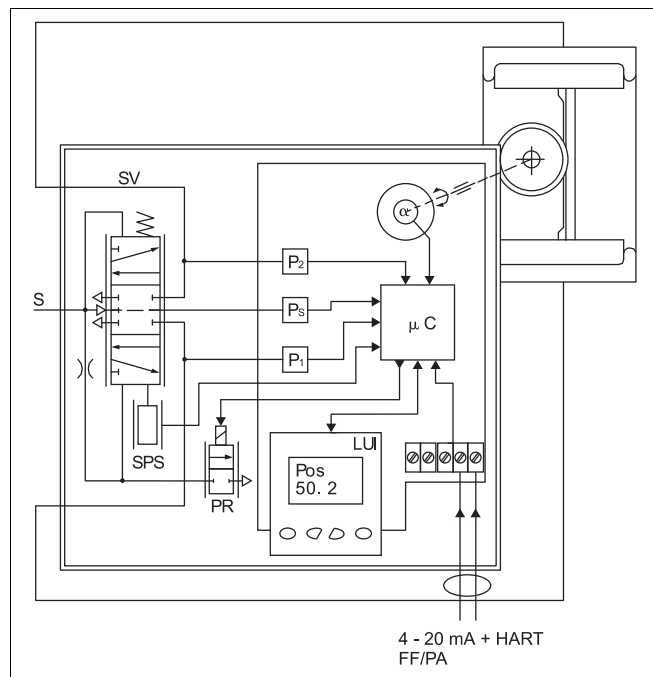

TECHNICAL SPECIFICATIONS

ND9000 INTELLIGENT VALVE CONTROLLER

General

Loop powered, no external power supply required.
 Suitable for rotary and linear valves.
 Actuator connections in accordance with VDI/VDE 3845 and IEC 60534-6 standards.
 Flush mounting on selected actuators
 Action: Double or single acting
 Travel range: Linear; 10–120 mm / 0.4–4.7 in
 rotary; 45–95 degrees. Measurement range 110° with freely rotating feedback shaft.

Environmental influence

Standard temperature range:
 -40° – +85 °C / -40° – +185 °F
 Arctic temperature range: -53° – +85 °C / -64° – +185 °
 Influence of temperature on valve position:
 0.5 % / 10 °K
 Influence of vibration on valve position:
 < 1 % under 2g 5–150 Hz,
 1g 150–300 Hz, 0.5g 300–2000 Hz

Enclosure

Material: ND9100: Anodized aluminum alloy and polymer composite
 ND9200: Anodised aluminum alloy and tempered glass
 ND9400: Stainless steel and polymer composite
 ND9300: Stainless steel
 Protection class: IP66, Nema 4x
 Pneumatic ports: G 1/4 (ND9100)
 1/4 NPT (ND9200, ND9300 & ND9400)
 Cable gland thread: M20x1.5 (ND9000)
 1/2 NPT (ND9000E2, ND9000U)
 Weight: 1.8 kg / 4.0 lbs (ND9100)
 3.4 kg / 7.5 lbs (ND9200)
 5.6 kg / 12.4 lbs (ND9400)
 8.6 kg / 19.0 lbs (ND9300)
 Mechanical and digital position indicator visible through main cover, not applicable to ND9200E2 and ND9300.
 Special corrosion resistant design or stainless steel housing available as an option for demanding environment.

Pneumatics

Supply pressure: 1.4–8 bar / 20–115 psi
 Effect of supply pressure on valve position:
 < 0.1 % at 10 % difference in inlet pressure
 Air quality: Acc. to ISO 8573-1
 Solid particles: Class 5 (3 – 5 µm filtration is recommended)
 Humidity: Class 1 (dew point 10 °C / 18 °F below minimum temperature is recommended)
 Oil class: 3 (or < 1 ppm)
 Capacity with 4 bar / 60 psi supply:
 5.5 Nm³/h / 3.3 scfm (spool valve 2)
 12 Nm³/h / 7.1 scfm (spool valve 3)
 38 Nm³ /h / 22,4 scfm (spool valve 6)
 Consumption with 4 bar / 60 psi supply in steady state position:
 < 0.6 Nm³/h / 0.35 scfm (spool valve 2 & 3)
 < 1.0 Nm³/h / 0.6 scfm (spool valve 6)

Electronics

HART
 Supply power: Loop powered, 4–20 mA
 Minimum signal: 3.6 mA
 Current max : 120 mA
 Load voltage: up to 9.7 VDC/20 mA (corresponding 485 Ω)
 Voltage: max. 30 VDC
 Polarity protection: -30 VDC
 Over current protection: active over 35 mA

Profibus PA and FOUNDATION fieldbus

Supply power: voltage 9–32 VDC, reverse polarity protection
 Max basic current: 17.2 mA
 Quiescent Current Draw: 16 mA
 Fault current (FDE): 3.9 mA

FOUNDATION fieldbus function block execution times

AO	20 ms
AI	20 ms
PID	20 ms
DO	20 ms
DI	15 ms
IS	15 ms
OS	15 ms

Performance with moderate constant-load actuators

Dead band: ≤ 0.1 %
 Hysteresis: < 0.5 %

Local User Interface (LUI) functions

- Local control of the valve
- Monitoring of valve position, target position, input signal, temperature, supply and actuator pressure difference
- Guided-startup function
- LUI may be locked remotely to prevent unauthorised access
- Calibration: Automatic / Manual linearization
- 1-point calibration
- Control configuration: aggressive, fast, optimum, stable, maximum stability
- HART version configuration: HART 6 or HART 7
- Configuration of the control valve
 - Rotation: valve rotation clockwise or counter-clockwise to close
 - Dead Angle
 - Low cut-off, cut-off safety range (default 2 %)
 - Positioner fail action, open/close
 - Signal direction: Direct/reverse acting
 - Actuator type, double/single acting
 - Valve type, rotary/linear
 - Language selection: English, German and French

Position transmitter (optional)

Output signal: 4–20 mA (galvanic isolation); 600 VDC
 Supply voltage: 12–30 VDC
 Resolution: 16 bit / 0.244 µA
 Linearity: < 0.05 % FS
 Temperature effect: < 0.35 % FS
 External load: max 0–780 Ω
 max 0–690 Ω for intrinsically safe
 Ex ia IIC T6 Ui ≤ 28 V
 Ex d IIC T4/T5/T6 Ui ≤ 30 V

APPROVALS AND ELECTRICAL VALUES, HART

Certificate	Approval	Electrical values
ATEX		
ND_X VTT 09 ATEX 033X VTT 09 ATEX 034X EN 60079-0: 2009/2012 EN 60079-11: 2012 EN 60079-26: 2007 EN 60079-31: 2008	II 1G Ex ia IIC T6...T4 Ga II 1D Ex ta IIIC T90 °C Da II 2 G Ex ib IIC T6...T4 Gb II 2 D Ex tb IIIC T90 °C Db	Input: $U_i \leq 28\text{ V}$, $I_i \leq 120\text{ mA}$, $P_i \leq 1\text{ W}$, $C_i \leq 22\text{ nF}$, $L_i \leq 53\text{ }\mu\text{H}$. Output: $U_o \leq 28\text{ V}$, $I_o \leq 120\text{ mA}$, $P_o \leq 1\text{ W}$, $C_o \leq 22\text{ nF}$, $L_o \leq 53\text{ }\mu\text{H}$
EN 60079-0: 2009/2012 EN 60079-11: 2012 EN 60079-15: 2010 EN 60079-31: 2008	II 3 G Ex nA IIC T6...T4 Gc II 3 D Ex tc IIIC T90 °C Dc	Input: $U_i \leq 30\text{ V}$, $I_i \leq 152\text{ mA}$ Output: $U_o \leq 30\text{ V}$, $I_o \leq 152\text{ mA}$
EN 60079-0: 2009/2012 EN 60079-11: 2012 EN 60079-15: 2010 EN 60079-31: 2008	II 3 G Ex ic IIC T6...T4 Gc II 3 D Ex tc IIIC T90 °C Dc	Input: $U_i \leq 30\text{ V}$, $I_i \leq 152\text{ mA}$, $P_{\text{max}} = \text{device limits itself}$, $C_i \leq 22\text{ nF}$, $L_i \leq 53\text{ }\mu\text{H}$. Output: $U_o \leq 30\text{ V}$, $I_o \leq 152\text{ mA}$, $P_{\text{max}} = \text{device limits itself}$, $C_o \leq 22\text{ nF}$, $L_o \leq 53\text{ }\mu\text{H}$
ND_E1 SIRA 11 ATEX 1006X EN 60079-0:2009 EN 60079-1:2007 EN 60079-31:2009	II 2 G Ex d IIC T6...T4 Gb II 2 D Ex tb IIIC T80 °C...T105 °C Db	Input: $U_i \leq 30\text{ V}$ Output: $U_o \leq 30\text{ V}$, $P_{\text{max}} = \text{device limits itself}$
IECEx		
ND_X IECEx VTT 10.0004X IECEx VTT 10.0005X IEC 60079-0: 2007/2011 IEC 60079-11: 2011 IEC 60079-26: 2006 IEC 60079-31: 2008	Ex ia IIC T6...T4 Ga Ex ta IIIC T90 °C Da Ex ib IIC T6...T4 Gb Ex tb IIIC T90 °C Db	Input: $U_i \leq 28\text{ V}$, $I_i \leq 120\text{ mA}$, $P_i \leq 1\text{ W}$, $C_i \leq 22\text{ nF}$, $L_i \leq 53\text{ }\mu\text{H}$ Output: $U_o \leq 28\text{ V}$, $I_o \leq 120\text{ mA}$, $P_o \leq 1\text{ W}$, $C_o \leq 22\text{ nF}$, $L_o \leq 53\text{ }\mu\text{H}$
IEC 60079-0: 2007/2011 IEC 60079-11: 2011 IEC 60079-15: 2010, IEC 60079-31: 2008	Ex nA IIC T6...T4 Gc Ex tc IIIC T90 °C Dc	Input: $U_i \leq 30\text{ V}$, $I_i \leq 152\text{ mA}$ Output: $U_o \leq 30\text{ V}$, $I_o \leq 152\text{ mA}$
IEC 60079-0: 2007/2011 IEC 60079-11: 2011 IEC 60079-15: 2010, IEC 60079-31: 2008	Ex ic IIC T6...T4 Gc Ex tc IIIC T90 °C Dc	Input: $U_i \leq 30\text{ V}$, $I_i \leq 152\text{ mA}$, $P_{\text{max}} = \text{device limits itself}$, $C_i \leq 22\text{ nF}$, $L_i \leq 53\text{ }\mu\text{H}$ Output: $U_o \leq 30\text{ V}$, $I_o \leq 152\text{ mA}$, $P_{\text{max}} = \text{device limits itself}$, $C_o \leq 22\text{ nF}$, $L_o \leq 53\text{ }\mu\text{H}$
ND_E1 IECEx SIR 11.0001X IEC 60079-0:2011 IEC 60079-1:2007 IEC 60079-31:2008	Ex d IIC T6...T4 Gb Ex tb IIIC T80 °C...T105 °C Db	Input: $U_i \leq 30\text{ V}$ Output: $U_o \leq 30\text{ V}$, $P_{\text{max}} = \text{device limits itself}$
INMETRO		
ND_Z NCC 12.0793 X NCC 12.0794 X ABNT NBR IEC 60079-0:2013 ABNT NBR IEC 60079-11:2009 ABNT NBR IEC 60079-26:2008 (2009) ABNT NBR IEC 60079-27:2010	Ex ia IIC T4/T5/T6 Ga Ex ia IIC T4/T5/T6 Gb	Input: $U_i \leq 28\text{ V}$, $I_i \leq 120\text{ mA}$, $P_i \leq 1\text{ W}$, $C_i \leq 22\text{ nF}$, $L_i \leq 53\text{ }\mu\text{H}$ Output: $U_o \leq 28\text{ V}$, $I_o \leq 120\text{ mA}$, $P_o \leq 1\text{ W}$, $C_o \leq 22\text{ nF}$, $L_o \leq 53\text{ }\mu\text{H}$
ABNT NBR IEC 60079-0:2013 ABNT NBR IEC 60079-11:2009 IEC 60079-15:2012 ABNT NBR IEC 60079-27:2010 ABNT NBR IEC 60529:2005	Ex nA IIC T4/T5/T6 Gc	Input: $U_i \leq 30\text{ V}$, $I_i \leq 152\text{ mA}$ Output: $U_o \leq 30\text{ V}$, $I_o \leq 152\text{ mA}$
ABNT NBR IEC 60079-0:2013 ABNT NBR IEC 60079-11:2009 ABNT NBR IEC 60079-27:2010 ABNT NBR IEC 60529:2005	Ex ic IIC T4/T5/T6 Gc	Input: $U_i \leq 30\text{ V}$, $I_i \leq 152\text{ mA}$, $P_{\text{max}} = \text{device limits itself}$, $C_i \leq 22\text{ nF}$, $L_i \leq 53\text{ }\mu\text{H}$. Output: $U_o \leq 30\text{ V}$, $I_o \leq 152\text{ mA}$, $P_{\text{max}} = \text{device limits itself}$, $C_o \leq 22\text{ nF}$, $L_o \leq 53\text{ }\mu\text{H}$
ND_E5 NCC 12.0795 X ABNT NBR IEC 60079-0:2013 ABNT NBR IEC 60079-1:2009 (2011) ABNT NBR IEC 60079-31:2011 ABNT NBR IEC 60529:2005	Ex d IIC T4/T5/T6 Gb Ex tb IIIC T100 °C Db IP66	Input: $U_i \leq 30\text{ V}$ Output: $U_o \leq 30\text{ V}$, $P_{\text{max}} = \text{device limits itself}$
cCSAus		
ND_U CSA C22.2 No. 0-M91, CSA C22.2 No. 94-M91, CSA C22.2 No. 142-M1987, CSA C22.2 No. 157-92, CSA C22.2 No. 213-M1987, CSA C22.2 No. 60079-0:11, CSA C22.2 No. 60079-11:11, CSA C22.2 No. 60079-15:12, CSA C22.2 No. 60529:05, ANSI/ISA 60079-0: 2009, ANSI/ISA 60079-11: 2012, ANSI/ISA 60079-15: 2012, FM 3600 November 1998, FM 3610 October 1999, FM 3611 October 1999, FM 3810-2005, ANSI/ NEMA 250:1991, ANSI/IEC 60529:2004	IS Class I, Division 1, Groups A, B, C, and D; T4/T5/T6 Ex ia IIC T4/T5/T6 Ga IS Class I, Zone 0 AEx ia IIC T4/T5/T6 Ga	Input: $U_i \leq 28\text{ V}$, $I_i \leq 120\text{ mA}$, $P_i \leq 1\text{ W}$, $C_i \leq 22\text{ nF}$, $L_i \leq 53\text{ }\mu\text{H}$ Output: $U_o \leq 28\text{ V}$, $I_o \leq 120\text{ mA}$, $P_o \leq 1\text{ W}$, $C_o \leq 22\text{ nF}$, $L_o \leq 53\text{ }\mu\text{H}$
ANSI/ISA 60079-0: 2009, ANSI/ISA 60079-11: 2012, ANSI/ISA 60079-15: 2012, FM 3600 November 1998, FM 3610 October 1999, FM 3611 October 1999, FM 3810-2005, ANSI/ NEMA 250:1991, ANSI/IEC 60529:2004	Class I, Division 2, Groups A, B, C, and D; T4/T5/T6 Ex nA IIC T4/T5/T6 Gc or Ex nA ia IIC T4/T5/T6 Gc Ga Class I, Zone 2 AEx nA IIC T4/T5/T6 Gc or Ex nA ia IIC T4/T5/T6 Gc Ga	Input: $U_i \leq 30\text{ V}$, $P_{\text{max}} = \text{device limits itself}$, $C_i \leq 22\text{ nF}$, $L_i \leq 53\text{ }\mu\text{H}$ Output: $U_o \leq 30\text{ V}$, $I_o \leq 152\text{ mA}$, $P_{\text{max}} = \text{device limits itself}$, $C_o \leq 22\text{ nF}$, $L_o \leq 53\text{ }\mu\text{H}$
ND_E5 CSA Std C22.2 No.25-1966, CSA Std C22.2 No. 30-M1986, CAN/CSA-C22.2 No.94-M91, C22.2 No. 142-M1987, CAN/CSA C22.2 61010-1-04, CAN/CSAC22.2 No 60079-0-07, CAN/CSA-C22.2 No 60079-1-07, CAN/ CSA C22.2 No 60079-31-12, CAN/CSA-C22.2 No. 60529-05, FM 3600 (1998), FM 3615 (2006), FM 3810 (2005), ANSI/ NEMA 250-1991, ISA 60079-0-07, ISA 60079-1-07, ISA 60079-31-2009, ANSI/IEC 60529:2004	Class I, Div 1, Groups B, C, D; Class II, Div 1, Groups E,F,G; Class III; T4...T6, Enclosure type 4X Ex d IIC T4...T6 AEx d IIC T4...T6 Ex tb IIIC T100 °C IP66 AEx tb IIIC T100 °C IP66	Input: $U_i \leq 30\text{ V}$ Output: $U_o \leq 30\text{ V}$, $P_{\text{max}} = \text{device limits itself}$
TIIS (JIS)		
ND_E4	Ex d IIC T6	Input: $U_i \leq 30\text{ V}$ Output: $U_o \leq 30\text{ V}$, $P_{\text{max}} = \text{device limits itself}$

APPROVALS AND ELECTRICAL VALUES, FOUNDATION fieldbus and Profibus PA

Certificate	Approval	Electrical values
ATEX		
ND_X VTT 09 ATEX 033X VTT 09 ATEX 034X EN 60079-0: 2009/2012 EN 60079-11: 2012 EN 60079-26: 2007 EN 60079-31: 2008 EN 60079-0: 2009/2012 EN 60079-11: 2012 EN 60079-15: 2010 EN 60079-31: 2008	II 1G Ex ia IIC T6...T4 Ga II 1D Ex ta IIIC T90 °C Da II 2 G Ex ib IIC T6...T4 Gb II 2 D Ex tb IIIC T90 °C Db	$U_i \leq 24 \text{ V}$, $I_i \leq 380 \text{ mA}$, $P_i \leq 5.32 \text{ W}$, $C_i \leq 5 \text{ nF}$, $L_i \leq 10 \mu\text{H}$. Comply with the requirements for FISCO field device
	II 3 G Ex nA IIC T6...T4 Gc II 3 D Ex tc IIIC T90 °C Dc	$U_i \leq 24 \text{ V}$
	II 3 G Ex ic IIC T6...T4 Gc II 3 D Ex tc IIIC T90 °C Dc	$U_i \leq 32 \text{ V}$, $I_i \leq 380 \text{ mA}$, $P_i \leq 5.32 \text{ W}$, $C_i \leq 5 \text{ nF}$, $L_i \leq 10 \mu\text{H}$. Comply with the requirements for FISCO Ex ic field device
ND_E1 SIRA 11 ATEX 1006X EN 60079-0:2009 EN 60079-1:2007 EN 60079-31:2009	II 2 G Ex d IIC T6...T4 Gb II 2 D Ex tb IIIC T80 °C...T105 °C Db	$U_i \leq 32 \text{ V}$
IECEX		
ND_X IECEX VTT 10.0004X IECEX VTT 10.0005X IEC 60079-0: 2007/2011 IEC 60079-11: 2011 IEC 60079-26: 2006 IEC 60079-31: 2008 IEC 60079-0: 2007/2011 IEC 60079-11: 2011 IEC 60079-15: 2010, IEC 60079-31: 2008	Ex ia IIC T6...T4 Ga Ex ta IIIC T90 °C Da Ex ib IIC T6...T4 Gb Ex tb IIIC T90 °C Db	$U_i \leq 24 \text{ V}$, $I_i \leq 380 \text{ mA}$, $P_i \leq 5.32 \text{ W}$, $C_i \leq 5 \text{ nF}$, $L_i \leq 10 \mu\text{H}$. Comply with the requirements for FISCO Ex ic field device
	Ex nA IIC T6...T4 Gc Ex tc IIIC T90 °C Dc	
	Ex ic IIC T6...T4 Gc Ex tc IIIC T90 °C Dc	$U_i \leq 32 \text{ V}$, $I_i \leq 380 \text{ mA}$, $P_i \leq 5.32 \text{ W}$, $C_i \leq 5 \text{ nF}$, $L_i \leq 10 \mu\text{H}$. Comply with the requirements for FISCO field device
ND_E1 IECEX SIR 11.0001X IEC 60079-0:2011 IEC 60079-1:2007 IEC 60079-31:2008	Ex d IIC T6...T4 Gb Ex tb IIIC T80 °C...T105 °C Db	$U_i \leq 32 \text{ V}$
INMETRO		
ND_Z NCC 12.0793 X NCC 12.0794 X ABNT NBR IEC 60079-0:2008 (2011) ABNT NBR IEC 60079-11:2009 ABNT NBR IEC 60079-26:2008 (2009) ABNT NBR IEC 60079-27:2010 ABNT NBR IEC 60079-0:2008 (2011) ABNT NBR IEC 60079-11:2009 IEC 60079-15:2010 ABNT NBR IEC 60079-27:2010 ABNT NBR IEC 60529:2009	Ex ia IIC T4/T5/T6 Ga Ex ia IIC T4/T5/T6 Gb	$U_i \leq 24 \text{ V}$, $I_i \leq 380 \text{ mA}$, $P_i \leq 5.32 \text{ W}$, $C_i \leq 5 \text{ nF}$, $L_i \leq 10 \mu\text{H}$. Comply with the requirements for FISCO field device
	Ex nA IIC T4/T5/T6 Gc $U_i \leq 24 \text{ V}$	$U_i \leq 24 \text{ V}$
	Ex ic IIC T4/T5/T6 Gc	$U_i \leq 32 \text{ V}$, $I_i \leq 380 \text{ mA}$, $P_i \leq 5.32 \text{ W}$, $C_i \leq 5 \text{ nF}$, $L_i \leq 10 \mu\text{H}$. Comply with the requirements for FISCO Ex ic field device
ND_E5 NCC 12.0795 X ABNT NBR IEC 60079-0:2008 (2011) ABNT NBR IEC 60079-1:2009 (2011) ABNT NBR IEC 60079-31:2011 ABNT NBR IEC 60529:2009	Ex d IIC T4/T5/T6 Gb Ex tb IIIC T100 °C Db IP66	$U_i \leq 32 \text{ V}$
cCSAus		
ND_U CSA C22.2 No. 0-M91, CSA C22.2 No. 94-M91, CSA C22.2 No. 142-M1987, CSA C22.2 No. 157-92, CSA C22.2 No. 213-M1987, CSA C22.2 No. 60079-0:11, CSA C22.2 No. 60079-11:11, CSA C22.2 No. 60079-15:12, CSA C22.2 No. 60529:05, ANSI/ISA 60079-0: 2009, ANSI/ISA 60079-11: 2012, ANSI/ISA 60079-15: 2012, FM 3600 November 1998, FM 3610 October 1999, FM 3611 October 1999, FM 3810-2005, ANSI/NEMA 250:1991, ANSI/IEC 60529:2004	Class I, Division 1, Groups A, B, C, and D; T4/T5/T6 Ex ia IIC T4/T5/T6 Ga Class I, Zone 0 AEx ia IIC T4/T5/T6 Ga	$U_i \leq 24 \text{ V}$, $I_i \leq 380 \text{ mA}$, $P_i \leq 5.32 \text{ W}$, $C_i \leq 5 \text{ nF}$, $L_i \leq 10 \mu\text{H}$. Comply with the requirements for FISCO field device
	Class I, Division 2, Groups A, B, C, and D; T4/T5/T6 Ex ic IIC T4/T5/T6 Gc Class I, Zone 2 AEx ic IIC T4/T5/T6 Gc	$U_i \leq 32 \text{ V}$, $I_i \leq 380 \text{ mA}$, $P_i \leq 5.32 \text{ W}$, $C_i \leq 5 \text{ nF}$, $L_i \leq 10 \mu\text{H}$. Comply with the requirements for FISCO Model Ex ic field device
ND_E5 CSA Std C22.2 No.25-1966, CSA Std C22.2 No.30-M1986, CAN/CSA-C22.2 No.94-M91, C22.2 No. 142-M1987, CAN/CSA C22.2 61010-1-04, CAN/CSAC22.2 No 60079-0-07, CAN/CSA-C22.2 No 60079-1-07, CAN/ CSA C22.2 No 60079-31-12, CAN/CSA-C22.2 No. 60529-05, FM 3600 (1998), FM 3615 (2006), FM 3810 (2005), ANSI/ NEMA 250-1991, ISA 60079-0-07, ISA 60079-1-07, ISA 60079-31-2009, ANSI/IEC 60529:2004	Class I, Div 1, Groups B, C, D; Class II, Div 1, Groups E, F, G; Class III; T4...T6, Enclosure type 4X Ex d IIC T4...T6 AEx d IIC T4...T6 Ex tb IIIC T100 °C IP66 AEx tb IIIC T100 °C IP66	$U_i \leq 32 \text{ V}$

Electromagnetic Protection

Electromagnetic compability acc. to
Emission: EN 61000-6-4 (2007) + A1(2011)
Immunity: EN 61000-6-2 (2005)

Safety

IEC 61508 compliant up to and
including SIL 2 by TUV

CE marking

EMC 2014/30/EU

ATEX 94/9/EC (until 19 April 2016)
ATEX 2014/34/EU (from 20 April 2016)

PROXIMITY SENSORS AND LIMIT SWITCHES (OPTIONAL WITH EXTENSION MODULE FOR ND9100, ND9200 & ND9300)

- Code D33 SST Sensor Dual Module
- Code D44 Namur Sensor Dual Module
- Code I02 P+F NJ2-12GK-SN, 2 sensors
- Code I09 P+F; NCB2-12GM35-N0
- Code I32 Omron E2E-X2Y1, micro switch, 2 sensors
- Code I41 P+F, NJ4-12GK-SN, 2 sensors
- Code I45 P+F NJ3-13GK-S1N, 2 sensors
- Code I56 IFC 2002-ARKG/UP, 2 sensors
- Code K05 Omron D2VW-5, micro switch, 2 sensors
- Code K06 Omron D2VW-01 gold plated, micro switch
- Code B06 Omron D2VW-01 gold plated, micro switch, 2 sensors.
(Bus powered, no external power and cabling needed).

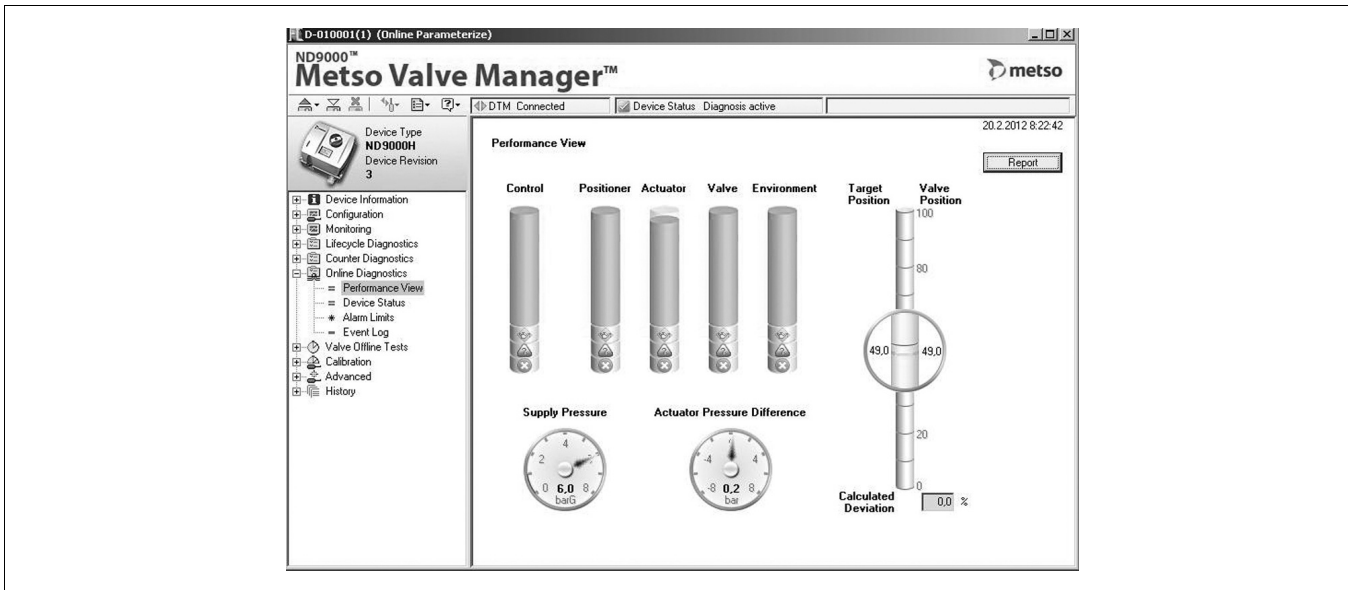

Figure 1. The Performance View of the Metso Valve Manager graphically displays indexes of the valve, actuator and positioner, as well as indexes of control performance and the application environment. Report will show explanations of the status of each component and guidelines for recommended actions.

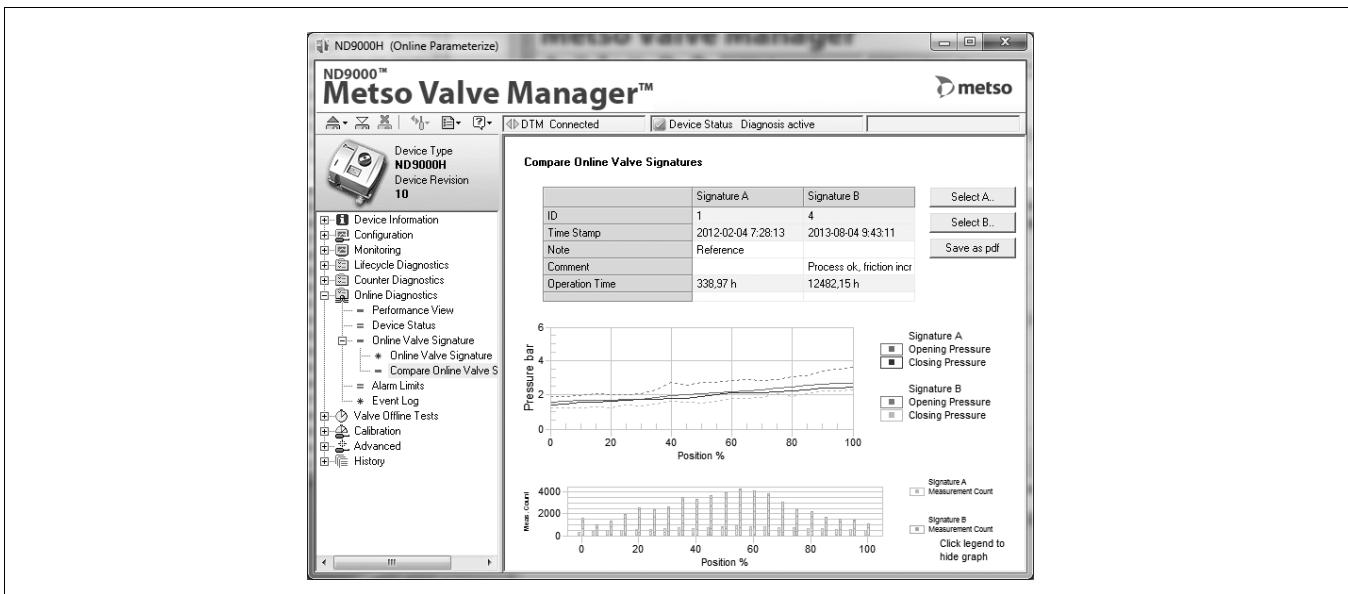
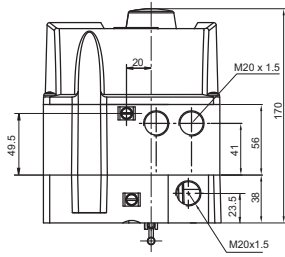

Figure 2. Valve Online Signature feature shows friction of the control valve online, under normal process conditions when ever the valve is changing position.

DIMENSIONS

ND9100 and ND9400

ND9100/I, ND9100/K and ND9100/B



ND9100

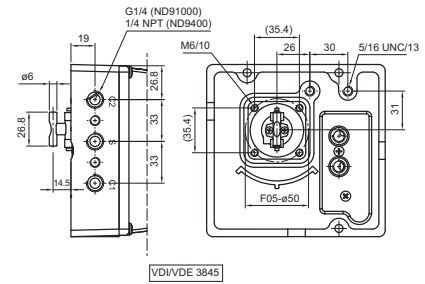
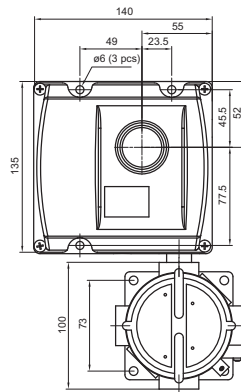
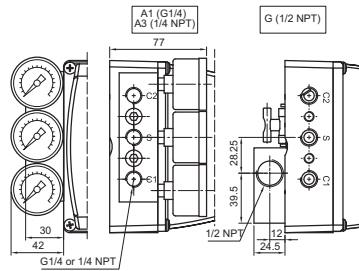
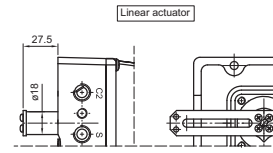
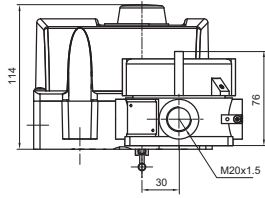

Option J

ND9200

ND9200/I, ND9200/K and ND9200/B

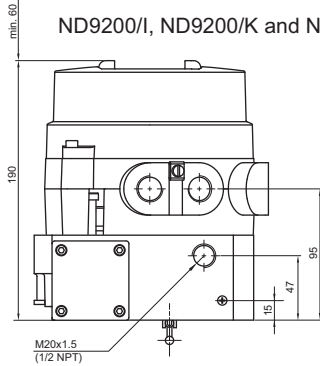

ND9200

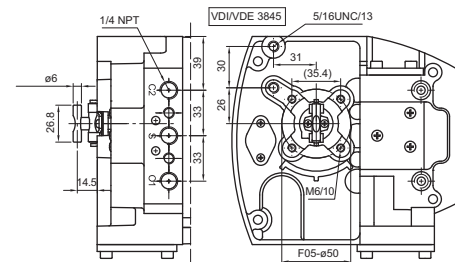
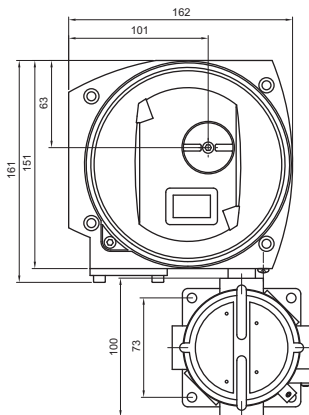
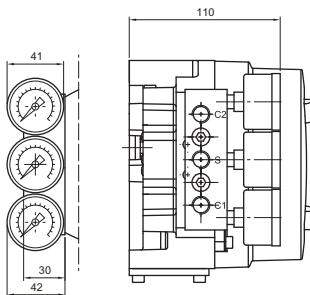
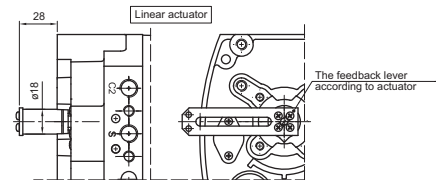
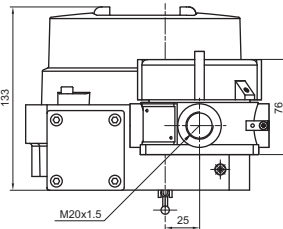

Option J

ND9300

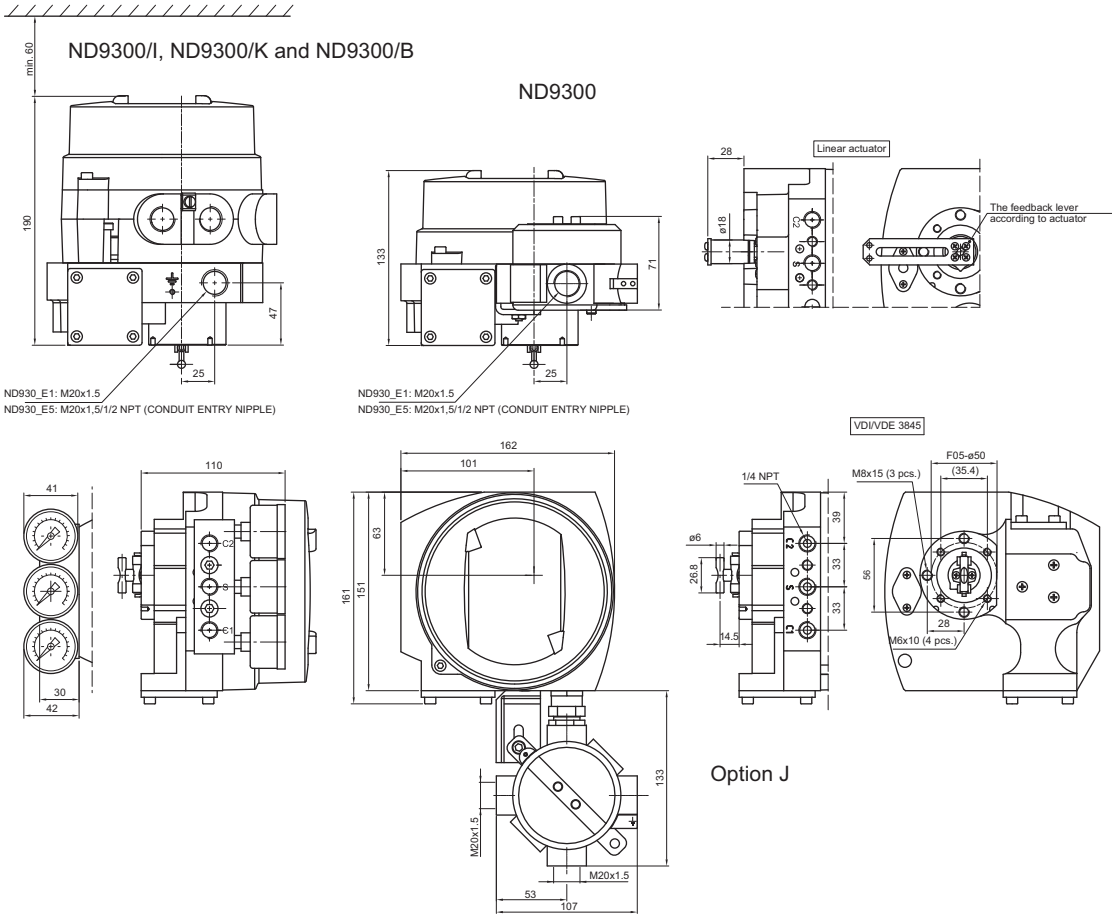

HOW TO ORDER

**INTELLIGENT VALVE CONTROLLER ND9000 /
LIMIT SWITCH (ND9000/D__, ND9000/I__, ND9000/K0_ or ND9000/B06)**

1.	2.	3.	4.	5.	6.	7.		8.	9.
ND	9	2	03	H	E1	T	/	K05	

1.	PRODUCT GROUP	
ND	Intelligent Valve Controller.	
2.	SERIES CODE	
9	Series 9000 valve controller with universal shaft and attachment face according to standard VDI/VDE 3845. Relevant shaft adapter included in mounting kits. When valve controllers are separate deliveries, shaft adapter kit is supplied.	
3.	ENCLOSURE	
1	Standard IP66 / NEMA 4X enclosure.	
2	Flameproof (Ex d) IP66 / NEMA 4X enclosure.	
3	Stainless steel flameproof (Ex d) IP66 / NEMA 4X enclosure.	
4	Stainless steel IP66 / NEMA 4X enclosure, polymer composite cover	
4.	SPOOL VALVE	PNEUMATIC CONNECTIONS (S, C1, C2)
02	Low capacity. Stroke volume of actuator < 1 dm ³ .	G 1/4 (ND9100), 1/4 NPT (ND9200/ND9300/ND9400).
03	Medium capacity. Stroke volume of actuator 1–3 dm ³ .	G 1/4 (ND9100), 1/4 NPT (ND9200/ND9300/ND9400).
06	High capacity. Stroke volume of actuator > 3 dm ³ .	G 1/4 (ND9100), 1/4 NPT (ND9200/ND9300/ND9400).
5.	COMMUNICATION / INPUT SIGNAL RANGE	
H	4–20 mA, HART (6 and 7) communication. Supply voltage 30 V DC. Load voltage: up to 9.7 V DC at 20 mA corresponding to 485 Ω (maximum voltage drop).	
F	FOUNDATION fieldbus, physical layer according to IEC 61158-2.	
P	Profibus PA, physical layer according to IEC 61158-2.	
6.	APPROVALS FOR HAZARDOUS AREAS	
N	No approvals for hazardous areas. M20 x 1.5 conduit entry. Temperature range -40° to +85 °C. Not applicable to 3. sign "20".	
N7	No approvals for hazardous areas. Like N, but this is with Russian language machine plate.	
X	<p>ATEX and IECEx certifications: II 1 G Ex ia IIC T6...T4 Ga II 2 G Ex ib IIC T6...T4 Gb II 1 D Ex ta IIIC T90 °C Da II 2 D Ex tb IIIC T90 °C Db Temperature range: T4: -40° to +80 °C; T5: < +65 °C; T6: < +50 °C.</p> <p>II 3 G Ex nA IIC T6...T4 Gc II 3 D Ex tc IIIC T90 °C Dc Temperature range: T4: -40° to +85 °C; T5: < +75 °C; T6: < +60 °C.</p> <p>II 3 G Ex ic IIC T6...T4 Gc II 3 D Ex tc IIIC T90 °C Dc Ex ic IIC T6...T4 Temperature range: T4: -40° to +85 °C; T5: < +75 °C; T6: < +60 °C.</p> <p>Available without limit switches or with ATEX or IECEx certified inductive limit switches. M20 x 1.5 conduit entry. With limit switch temperature range is updated according to switch type. NOTE: Dust approval: II 1 D Ex ta IIIC T90 °C Da II 2 D Ex tb IIIC T90 °C Db II 3 D Ex tc IIIC T90 °C Dc not applicable to 3. sign "4".</p>	
X7	ATEX and IECEx certifications: Like X, but this is with Russian language machine plate. Check details of marking from X	

6.	APPROVALS OF STANDARD ENCLOSURE VALVE CONTROLLER	
U	<p>cCSAus certifications: IS Class I, Division 1, Groups A, B, C, and D; T4/T5/T6 Ex ia IIC T4/T5/T6 Ga IS Class I, Zone 0 AEx ia IIC T4/T5/T6 Ga Temperature range: T4: -40° to +80 °C; T5: < +65 °C; T6: < +50 °C. applicable for 5. sign H: Class I, Division 2, Groups A, B, C, and D; T4/T5/T6 Ex nA IIC T4/T5/T6 Gc or Ex nA ia IIC T4/T5/T6 Gc Ga Class I, Zone 2 AEx nA IIC T4/T5/T6 Gc or Ex nA ia IIC T4/T5/T6 Gc Ga Temperature range: T4: -40° to +80 °C; T5: < +65 °C; T6: < +50 °C.</p> <p>Applicable for 5. sign F or P: Class I, Division 2, Groups A, B, C, and D; T4/T5/T6 Ex ic IIC T4/T5/T6 Gc Class I, Zone 2 AEx ic IIC T4/T5/T6 Gc Temperature range: T4: -40° to +80 °C; T5: < +65 °C; T6: < +50 °C. No Zener Barrier needed. 1/2 NPT conduit entry. With limit switch temperature range is updated according to switch type.</p>	
Z	<p>INMETRO certifications: Ex ia IIC T4/T5/T6 Ga Ex ia IIC T4/T5/T6 Ex ia IIC T4/T5/T6 Gb Temperature range: T4: -40° to +80 °C; T5: < +65 °C; T6: < +50 °C.</p> <p>Ex nA IIC T4/T5/T6 Gc Temperature range: T4: -40° to +85 °C; T5: < +75 °C; T6: < +60 °C.</p> <p>Ex ic IIC T4/T5/T6 Gc Ex ic IIC T4/T5/T6 Temperature range: T4: -40° to +85 °C; T5: < +75 °C; T6: < +60 °C.</p> <p>Not applicable to 3. sign "2" or "4". Available without limit switches or with IECEx certified inductive limit switches. M20 x 1.5 conduit entry. With limit switch temperature range is updated according to switch type.</p>	
E1	<p>ATEX and IECEx certifications: II 2 G Ex d IIC T6...T4 Gb II 2 D Ex tb IIIC T80 °C...T105 °C Db Temperature range: T4: -40° to +85 °C; T5: < +75 °C; T6: < +60 °C. Not applicable to 3. sign "1" or "4". M20 x 1.5 conduit entry</p>	
E2	<p>cCSAus certification: Class I, Div 1, Groups B, C, D; Class II, Div 1, Groups E, F, G; Class III; T4...T6, Enclosure type 4X Ex d IIC T4...T6 AEx d IIC T4...T6 Ex tb IIIC T100 °C IP66 AEx tb IIIC T100 °C IP66 Temperature range: T4: -40° to +85 °C; T5: < +75 °C; T6: < +60 °C. Not applicable to 3. sign "1" or "4". 1/2 NPT conduit entry.</p>	
E4	<p>TIIS (JIS) certifications: Ex d II C T6 Temperature range: T6: -20° to +60 °C. Applicable only to 3. sign "2". Applicable only to 5. sign "H". Not available with any limit switches (8. sign "I" or "K"). G 1/2 or 1/2 NPT conduit entry. Delivered always with TIIS (JIS) approved cable gland and conduit entry nipple (accessory CG42 or CG41), see type code from Accessories for Positioners item 10: CG42: G 1/2 Conduit entry and Cable entry adapter. CG41: 1/2 NPT Conduit entry and Cable entry adapter.</p>	
E5	<p>INMETRO certification: Ex d IIC T4/T5/T6 Gb Ex tb IIIC T100 °C Db IP66 Temperature range: T4: -40° to +85 °C; T5: < +75 °C; T6: < +60 °C. Not applicable to 3. sign "1" or "4". M20 x 1.5 conduit entry.</p>	
E7	ATEX and IECEx certifications: Like E1, but this is with Russian language machine plate. Check details of marking from E1	

7.	OPTIONS OF VALVE CONTROLLER
T	<p>Internal 2-wire (passive) position transmitter. Analog position feedback signal, output 4–20 mA, supply voltage 12–30 V DC, external load resistance 0–780 Ω.</p> <p>ND91_HXT, ND91_HZT, ND92_HXT, ND93_HXT, ND93_HZT, ND94_HXT: II 1 G Ex ia IIC T6...T4 Ga II 1 D Ex ta IIIC T90 °C Da II 2 G Ex ib IIC T6...T4 Gb II 2 D Ex tb IIIC T90 °C Db $U_i \leq 28$ V, $I_i \leq 120$ mA, $P_i \leq 1$ W, $C_i \leq 22$ nF, $L_i \leq 53$ μH, external load resistance 0–690 Ω.</p> <p>ND91_HXT, ND91_HZT, ND92_HXT, ND93_HXT, ND93_HZT, ND94_HXT: II 3 G Ex nA IIC T6...T4 Gc II 3 D Ex tc IIIC T90 °C Dc $U_i \leq 30$ V, $I_i \leq 152$ mA II 3 G Ex ic IIC T6...T4 Gc II 3 D Ex tc IIIC T90 °C Dc $U_i \leq 30$ V, $I_i \leq 152$ mA, Pmax = device limits itself, $C_i \leq 22$ nF, $L_i \leq 53$ μH, external load resistance 0–780 Ω.</p> <p>ND91_HUT, ND92_HUT, ND94_HUT and ND93_HU1T: Class I, Division 1, Groups A, B, C, and D; T4/T5/T6 Ex ia IIC T4/T5/T6 Ga Class I, Zone 0 AEx ia IIC T4/T5/T6 Ga $U_i \leq 28$ V, $I_i \leq 120$ mA, $P_i \leq 1$ W, $C_i \leq 22$ nF, $L_i \leq 53$ μH, external load resistance 0–690 Ω.</p> <p>Class I, Division 2, Groups A, B, C, and D; T4/T5/T6 Ex nA IIC T4/T5/T6 Gc or Ex nA ia IIC T4/T5/T6 Gc Ga Class I, Zone 2 AEx nA IIC T4/T5/T6 Gc or Ex nA ia IIC T4/T5/T6 Gc Ga $U_i \leq 30$ V, Pmax = device limits itself, $C_i \leq 22$ nF, $L_i \leq 53$ μH, external load resistance 0–780 Ω.</p> <p>ND92_HE1T, ND92_HE2T, ND92_HE4T, ND92_HE5T, ND93_HE1T, ND93_HE5T: $U_i \leq 30$ V, Pmax = device limits itself, external load resistance 0–780 Ω. Applicable to 5. sign "H".</p>
R	<p>Remote mounting Applicable only to 3. sign "1" Requires always external position measurement. For rotary actuator see accessories type code. Output values for: HART $U_o(\text{Voc}) = 3.53$ V, $I_o(\text{Isc}) = 12.6$ mA, $P_o = 11.1$ mW, $C_o(\text{Ca}) = 10$ nF, $L_o(\text{La}) = 10$ μH. Foundation Fieldbus and Profibus $U_o(\text{Voc}) = 5.0$ V, $I_o(\text{Isc}) = 17.8$ mA, $P_o = 22.2$ mW, $C_o(\text{Ca}) = 10$ nF, $L_o(\text{La}) = 10$ μH.</p> <p>NOTE Dust approval: II 1 D Ex ta IIIC T90 °C Da II 2 D Ex tb IIIC T90 °C Db II 3 D Ex tc IIIC T90 °C Dc Not applicable to 6. sign "X"</p>
C	<p>Arctic temperature option. Temperature range -53 – +85 °C / -64 – +185 °F Applicable to 3. sign "2 and 3" Applicable to 6. sign "X", "E1", "E2", "E7" and "U" Not applicable to 7. sign J (External junction box) Note, Limit switch may limit the temperature range</p>
J	<p>ND91_H, ND94_H, ND92_H and ND93_H: External junction box for all 4–20 mA wirings, including position transmitter, if applicable. Junction box is connected to the enclosure, 2 pcs. M20 x 1.5 conduit entry.</p> <p>ND91_F, ND92_F, ND94_F, ND93_F, ND91_P, ND92_P, ND94_P and ND93_P: External junction box for wirings, including option for parallel connection of external surge protector. Junction box is connected to the enclosure, 2 pcs. M20 x 1.5 conduit entry. Applicable to 6. sign "N", "X", "Z", "E1", "E2" or "E7".</p>
G	<p>Exhaust adapter. ND9100 and ND9400: 1x 1/2 NPT thread, ND9200 and ND9300: 2x 1/2 NPT thread.</p>
Y	<p>Special construction.</p>

8.	LIMIT SWITCH TYPE
	<p>Inductive proximity switches, 2 pcs. IP66 / NEMA 4X enclosure. M20 x 1.5 conduit entry (2 pcs.). Option E2: 1/2 NPT conduit entry (2 pcs.). Limit switches applicable only with ND9100, ND9200 and ND9300.</p>
D33	<p>Metso; SST Sensor Dual Module, NO, 8–125 V DC / 24–125 V AC Temperature range -40° to +82 °C / -40° to +179 °F. Applicable to 6. sign "N", "E1", "E2" and "E5".</p>
D44	<p>Metso; Namur Sensor Dual Module, DC; > 3 mA; < 1 mA. Temperature range -40° to +82 °C / -40° to +179 °F. Applicable to 6. sign "N", "U", "E1", "E2" and "E5".</p>
I02	<p>P+F; NJ2-12GK-SN, 2-wire type, DC; > 3 mA; < 1 mA, NAMUR NC. Temperature range: -40° to +85 °C / -40° to +185 °F. Not applicable to 6. sign "E4".</p>
I09	<p>P+F; NCB2-12GM35-N0, 2-wire type, DC; > 3 mA; < 1 mA, NAMUR NC Temperature range: -25° to +85 °C / -13° to +185 °F. Not applicable to 6. sign "E4" Usable up to SIL2 acc. to IEC61508.</p>
I32	<p>Omron E2E-X2Y1, 2-wire type; AC; <100 mA; 24–240 V AC. Temperature range: -40° to +85 °C / -40° to +185 °F. Applicable to 6. sign "N". Temperature range: -25° to +75 °C / -13° to +167 °F. Applicable to 6. sign "E1", "E2" and "E5".</p>
I41	<p>P+F; NJ4-12GK-SN, 2-wire, DC; > 3 mA; < 1 mA, NAMUR NC Temperature range -50 ... +85 °C / -58 ... 185 °F) Applicable to 6. sign "N", "X", "U", "E1", "E2" or "E7". Note that device may limit temperature range.</p>
I45	<p>P+F; NJ3-18GK-S1N, 3-wire type, DC; > 3 mA; < 1 mA, NAMUR NO. Temperature range: -25° to +85 °C / -13° to +185 °F. Not applicable to 6. sign "E4". Usable up to SIL3 acc. to IEC61508</p>
I56	<p>ifm; IFC2002-ARKG/UP, 2-wire type, DC; 150 mA, 10–36 V DC, leakage current < 0.6 mA. Temperature range: -20° to +85 °C / -4° to +185 °F. Not applicable to 6. sign "X", "Z", "U", "E2" and "E4".</p>
	<p>Mechanical micro switches, 2 pcs. IP66 / NEMA 4X enclosure. M20 x 1.5 conduit entry (2 pcs.). Option E2: 1/2 NPT conduit entry (2 pcs.). Limit switches applicable only with ND9100, ND9200 and ND9300</p>
K05	<p>Omron D2VW-5, 3 A - 250 V AC, 0.4 A - 125 V DC, 5 A - 30 V DC. Temperature range: -40° to +85 °C / -40° to +185 °F. Not applicable to 6. sign "X", "Z", "U" and "E4".</p>
K06	<p>Omron D2VW-01, gold plated contacts, 100 mA - 30 V DC / 125 V AC. Temperature range: -40° to +85 °C / -40° to +185 °F. Not applicable to 6. sign "X", "Z", "U" and "E4".</p>
	<p>Bus powered mechanical micro switches, 2 pcs. Applicable to ND9000F and ND9000P only. IP66 / NEMA 4X enclosure. M20 x 1.5 conduit entry (2 pcs.). Option E2: 1/2 NPT conduit entry (2 pcs.).</p>
B06	<p>Omron D2VW-01, gold plated contacts; Bus Powered, no external power needed. Temperature range: -40° to +85 °C / -40° to +185 °F. Not applicable to 5. sign "H". Not applicable to 6. sign "E4".</p>

9.	OPTIONS OF LIMIT SWITCH
Y	<p>Special construction.</p>

ADDITIONAL ACCESSORIES

FILTER REGULATOR	
K	Filter regulator for supply air. Filter size 5 µm. Pressure gauge, scale bar/psi/kPa, basic material brass, nickel plated, housing stainless steel, glycerine filled. Temperature range -40 °C...+82 °C / -40 °F... +180 °F. K option includes a thread nipple 1/4"NPT to 1/4"NPT between filter regulator and positioner which is suitable with ND9200 & ND9300 positioner options A3 and A5 (1/4NPT AIR CONNECTION). Supply air connector in the filter regulator is female 1/4".
K1	Filter regulator for supply air. Filter size 5 µm. Pressure gauge, scale bar/psi/kPa, basic material brass, nickel plated, housing stainless steel, glycerine filled. Temperature range -40 °C...+82 °C / -40 °F... +180 °F. K1 option includes a thread nipple 1/4"NPT to G1/4" between filter regulator and positioner which is suitable with ND9100 and ND9400 positioner and with option A1 (G1/4 AIR CONNECTION). Supply air connector in the filter regulator is female 1/4".
K2	Stainless steel (AISI 316) filter regulator for supply air. Filter size 5 µm. Pressure gauge, scale bar/psi/kPa/kg/cm2 ,silicone oil, AISI 316, Temperature range -40 °C... +80 °C / -40 °F... +176 °F.

CONDUIT ENTRY NIPPLES	
CE07	1/2 NPT conduit entry nipples M20x1.5 / 1/2 NPT (ND9100 and ND9400)
CE08	R1/2 (PF1/2) conduit entry nipples M20x1.5 / R1/2 (ND9100 and ND9400)
CE09	1/2 NPT conduit entry nipples Brass M20x1.5 / 1/2 NPT, Exd approved (ND9200)
CE19	1/2 NPT conduit entry nipples Stainless Steel M20x1.5 / 1/2 NPT, Exd approved (ND 9300)

CABLE GLANDS	
	Not to be used together with conduit entry nipples (CE_) or connection plugs (P_).
CG5	M20x1.5 grey/plastic, IP66
CG6	M20x1.5 blue/plastic, IP66, Ex e
CG42	G 1/2 Conduit entry and Cable entry adapter, JIS approved (ND9200H)
CG41	1/2 NPT Conduit entry and Cable entry adapter, JIS approved (ND9200H)

PRESSURE GAUGES AND CONNECTION BLOCKS	
A1	Pressure gauges, scale bar/psi/kPa, basic material brass, nickel plated, housing stainless steel, glycerine filled. Temperature range -40 ... +85 °C / -40 ... +185 °F. Pneumatic connection block, material AISI1Mg, anodized grey. Connections G1/4 (S, C1, C2).
A1B	As A1 but includes two pressure gauges with connections G1/4 (S, C2). Use with in single acting use only.
A3	Pressure gauges, scale bar/psi/kPa, basic material brass, nickel plated, housing stainless steel, glycerine filled. Temperature range -40 ... +85 °C / -40 ... +185 °F. Pneumatic connection block, material AISI1Mg, anodized grey. Connections 1/4 NPT (S, C1, C2), converts also ND91_ connections to 1/4 NPT.
A3B	As A3 but two pressure gauges with connections 1/4 NPT (S, C2). Converts also ND91_ connections to 1/4 NPT. Use with in single acting use only.
A5	Pneumatic connection block, converts ND91_ connections to 1/4 NPT. Material AISI1Mg, anodized grey. Connections 1/4 NPT (S, C1, C2). Only for ND9100.
A6	Pressure gauges with connections G1/4. Material AISI 316. Only for ND9100 and ND9400
A7	Pressure gauges with connections 1/4 NPT. Material AISI 316. Only for ND9100 and ND9400
A10	Pressure gauges with connections 1/4 NPT for ND9300 or ND9400 AISI 316, pressure gauges for severe off-shore use, safety glass window.

CONNECTION PLUGS	
	Not to be used together with conduit entry nipples (CE_) or cableglands (CG_).
P1H	ND9000H (HART): Connection plug according to M20x1.5 / DIN 43650A (ISO 4400). Not applicable with 5.sign "F" and "P".
P4H	Valve controller and limit switch with connection plugs (1 + 1 pc) ND9000 (HART): M20x1.5 / DIN 43650A (ISO 4400). ND9000/K00 or 2 wire ND9100/100. Not applicable with 5.sign "F" and "P".
P2F	ND9000F and ND9000F/B06 (FOUNDATION fieldbus): Connection plug male eurofast, Turck FSV49, M20x1.5 / M12. Not applicable with 5.sign "H" and "P".
P3F	ND9000F and ND9000F/B06 (FOUNDATION fieldbus): Connection plug male minifast, Turck RSFV49, M20x1.5 / 7/8". Not applicable with 5.sign "H" and "P".
P2P	ND9000P and ND9000P/B06 (Profibus PA): Connection plug male, Weidmuller 842593, M20x1.5 / M12. Not applicable with 5.sign "H" and "F".
P3P	ND9000P and ND9000P/B06 (Profibus PA): Connection plug male minifast, Turck RSFV48, M20x1.5 / 7/8". Not applicable with 5.sign "H" and "F".

DRIVER SETS	
	Driver sets including the needed parts when assembling ND9000 on rotary actuators with VDI/VDE 3845 attachment face, Neles E series actuators or Neles standard mounting faces. Select the correct driver set according to the actuator and the pneumatic connections of valve controller or gauge block when applicable. Note! Earlier the DS04 was delivered with bareshaft positioners as default. This practice is no longer valid, the needed driver set must be ordered as an accessory.
DS01	Driver set for ND7100 / ND9100 / ND9400 on actuators with VDI/VDE3845 attachment face. Set includes the G1/4 plug for single acting actuators. The driver set should also be applied with all ND7/9 with gauge blocks A1, A2 or A6.
DS02	Driver set for ND72/92/93 on actuators with VDI/VDE 3845 attachment face. Set includes the 1/4NPT plug for single acting actuators. The driver set should also be applied with all ND with gauge blocks A3, A5, A7 or A10.
DS04	General driver set for ND71/72/91/92/94/93 on actuators with VDI/VDE 3845, Neles E-series actuators and Neles standard attachment face (e.g. when replacing NE/NP7 or ND800 with S2 shaft). Earlier default driver set. Includes 1/8NPT, 1/4NPT and G1/4 plugs when used with single acting actuators or flush mounted on E-series actuators.

3RD PARTY MOUNTING SETS	
	Mounting sets between the ND9000 generation valve controllers and linear actuators, including bracket and ball joint based feedback system. Note! Sets are including the pneumatic plugs needed when used with single acting actuators. Note! All available mounting sets listed in http://www2.stonel.com/utilities/metso/mkdbase_open.htm
MS01	Mounting set for linear actuators, attachment face according to IEC 60534-6, stroke length 10-55 mm. (H116240)
MS02	Mounting set for linear actuators, attachment face according to IEC 60534-6, stroke length 55-120 mm. (H120404)
MS03	Mounting set for Masoneilan 87/88 actuators, sizes 6...23. Stroke length 12-64 mm. (H120809)

REMOTE MOUNTING ACCESSORIES		
	ID code	Description
RR01	C0217108	ND remote mount rotary sensor QNCOK05HDM
RR02	C0215954	ND remote mount rotary sensor QNCAK05HDM
RC01	H144183	Cable assembly remote mount sensor cable 1.2 m, straight connector
RC02	H126145	Cable assembly remote mount sensor cable 3.0 m, angle connector
RC03	H127093	Cable assembly remote mount sensor cable 30 m, angle connector

Metso Corporation

Töölönlahdenkatu 2, PO Box 1220, 00100 Helsinki, Finland
Tel. +358 20 484 100

Metso Flow Control Inc.

Vanha Porvoontie 229, P.O. Box 304, FI-01301 VANTAA, Finland.
Tel. +358 20 483 150. Fax +358 20 483 151

www.metso.com/valves

Subject to change without prior notice. Product names in this
bulletin are all trademarks of Metso Flow Control Inc.

