

 **OPD**EXP

*Power, modularity  
and flexibility:  
the excellence  
in the control.*

**TDE MACNO**  
*give life to technology*



### ACTIVE FRONT END REGENERATIVE UNIT CONVERTER

Converter Active Front End acts as an ac/dc rectifier, controlling two-direction exchange of power. (absorption or power regeneration) according to the needs of the load. The control is made by a voltage loop (V bus dc), and a current loop, that provides sinusoidal current under any condition of load (the part of reactive power exchanged with the grid can be set by the user).

### ADVANTAGES

AFE provides energy savings for all applications that require regeneration of energy in mains, as an alternative to the dissipative braking resistors. Regeneration units with sinusoidal current and low harmonic content.

### SPECIAL FUNCTIONS

- Power factor = 1 adjustable
- Mains voltage compensation
- Energy Saving
- Constant and high dc bus voltage, with no influence by the mains voltage fluctuation.
- Bidirectional power exchange between ac mains and dc bus
- Current THD lower then 3% with LCL clean power filter

### MAIN APPLICATION FIELDS

- Paper machine
- Metals process lines
- Converting
- Unwinders
- Electrosplindles
- Test Stands
- Cableways
- Cranes and Hoists
- Centrifuges
- Cutoff applications for glass, board or metal
- Renewable energy (wind, water, solar)

### CONVERTITORE RIGENERATIVO ACTIVE FRONT END

Il convertitore AC-DC Rigenerativo Active Front End agisce come un raddrizzatore ac - dc, controllando lo scambio bidirezionale della potenza assorbita - rigenerata, a seconda del funzionamento del carico.

Il controllo si compone di un anello di tensione ( Bus V dc) e uno di corrente che fornisce corrente sinusoidale in qualsiasi condizione di carico (la quota di potenza reattiva verso la rete, può essere impostata dall'utilizzatore).

### VANTAGGI

AFE permette un risparmio energetico per tutte le applicazioni che richiedono la rigenerazione di energia in linea, in alternativa all'utilizzo di resistenze di frenatura dissipative. Unità di rigenerazione a corrente sinusoidale a basso contenuto armonico.

### FUNZIONI SPECIALI

- Fattore di potenza = 1 regolabile
- Compensazione delle variazioni di tensione di linea
- Risparmio energetico
- Controllo del bus dc anche con tensione di rete fluttuante
- Flusso bidirezionale della potenza
- THD inferiore al 3% con filtri LCL clean power

### SETTORI APPLICATIVI

- Macchine per carta
- Linee lavorazione metalli
- Impianti di trasformazione
- Bobinatrici
- Elettromandri
- Banche prova
- Impianti a fune e ascensori
- Centrifughe applicazioni di taglio per il vetro, cartone o metallo
- Energie rinnovabili (eolico, turbine ad acqua, solare)

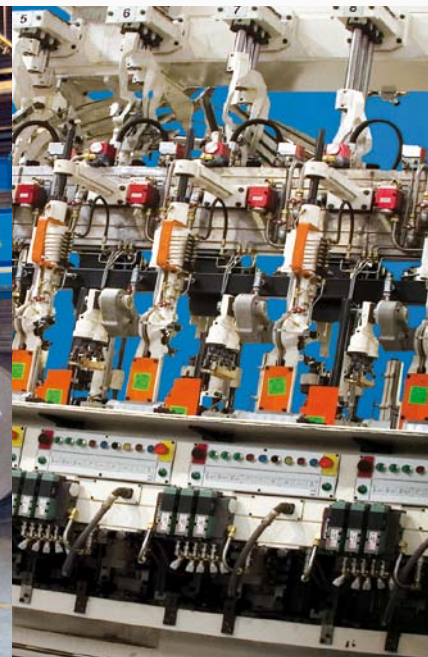
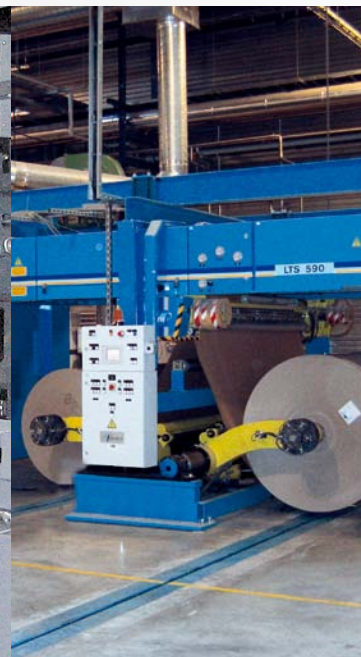
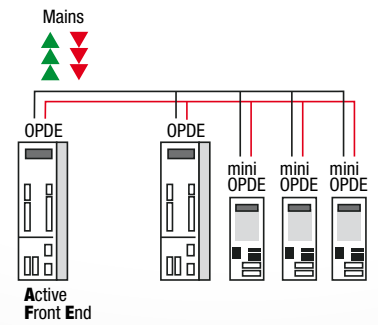
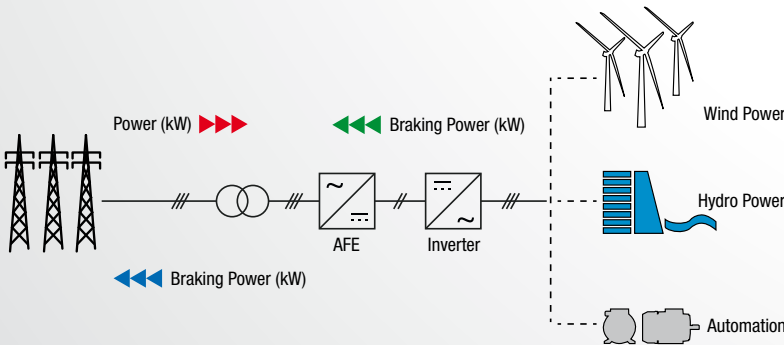



## UNIVERSAL CONTROL FOR ELECTRIC MOTORS

### CONFIGURATION MODES

<b>OPD EXP V</b>	INVERTER	<i>Field Oriented Control – Vector V/F / Controllo vettoriale ad orientamento di campo – Vettoriale V/F</i>
<b>OPD EXP B</b>	BRUSHLESS	<i>With feedback and function weakening area / Con feedback e funzione deflussaggio</i>
<b>OPD EXP B</b>	BRUSHLESS	<i>Sensorless / Sensorless</i>
<b>OPD EXP A</b>	ACTIVE FRONT END	<i>Sinusoidal regeneration unit / Unità di rigenerazione in rete a corrente sinusoidale</i>
<b>OPD EXP S</b>	SOLAR	<i>For solar, wind turbines / per solare, eolico, turbine</i>
<b>OPD EXP C</b>	CHOPPER	<i>For DC motors / per motori in corrente continua</i>
<b>OPD EXP M</b>	STARTER	<i>For motors and generators start-up with line synchronization Per l'avviamento e la sincronizzazione in rete di motori e generatori</i>
<b>OPD EXP R</b>	RELUCTANCE	<i>For reluctance motors / Per motori a riluttanza</i>

**INNOVATIVE TECHNOLOGY** • *New generation 32 bit floating point DSP (150 Mips)* • *LogicLab PLC on board, programmable according to IEC 61131-3* • *OPD EXPLORER configuration tool for drive programming* • **SAFE TORQUE OFF: (STO)** function according to EN-ISO 61800-5-2 (SIL2) EN ISO 13849-1 (performance level D) Certificate of conformity by TUV (AK 60026361 0001)



		Mini OpenDrive EXP							OpenDrive EXP (400 V)																									
		230V				400 V			S			M			L			X			1			2			3							
SIZE		04	11	22	30	08	15	30	03	07	12	15	22	32	40	48	60	70	90	110	150	175	220	250	310	370	460							
Overload 120% x 30s	POWER kW	0,4	1,1	2,2	3	0,8	1,5	3	1,5	3	5,5	7,5	11	18,5	22	22	37	37	55	55	75	90	132	132	160	200	250							
	I rates (A rms)	2,7	6,7	9,9	11,8	2,7	4,5	8	3,6	8,3	14,2	17,8	26	37,9	47,4	54,5	68,1	79,3	103	118,4	165,8	195,4	248,6	281,8	348,1	414,4	522,1							
Overload 150% x 30s	POWER kW	0,4	1,1	2,2	3	0,8	1,5	3	1,5	3	5,5	7,5	11	15	18,5	22	30	37	45	55	75	90	110	132	160	200	250							
	I rates (A rms)	2,4	5,9	8,8	10,5	2,4	4	7,1	3,2	7,4	12,6	15,8	23,2	33,7	42,2	48,5	60,6	70,6	91,7	105,4	147,6	173,9	221,3	250,9	309,9	368,9	464,8							
Overload 200% x 30s	POWER kW	0,4	1,1	2,2	3	0,8	1,5	3	1,1	2,2	4	5,5	7,5	11	15	18,5	22	30	37	45	55	75	90	110	132	160	200							
	I rates (A rms)	1,9	4,8	7,2	8,5	1,9	3,2	5,8	2,6	6	10,2	12,8	18,8	27,3	34,2	39,3	49,1	57,2	74,3	85,4	119,6	140,9	179,3	203,3	251,1	298,8	376,6							
Overload 200% x 3s +155% x 30s	POWER kW	0,4	1,1	2,2	3	0,8	1,5	3	1,5	3	5,5	7,5	11	15	18,5	22	30	30	37	45	55	75	110	110	132	160	200							
	I rates (A rms)	2,3	5,6	8,4	10	2,3	3,8	6,8	3	7	12	15	22	32	40	46	57,5	67	87	100	140	165	210	238	294	350	441							
Size (mm)	H	257							303			303			322			322			675			900			900							
	W	74							89			116			137			194			251			478			678							
	D	176							253			253			253			253			290			296			296							
Weight (kg)	2							3,5			4,8			5,5			6,4			9,3			10			22			65			80		
Approvals	CE							CE																										



AC Input: 3x200 ÷ 460 Vac  
 DC input: 280 V ÷ 750 V  
 Anybus port  
 Safe Torque Off (STO) (option)  
 Regulation Power Supply 24 Vdc

Keypad & display

Connector for the remotable keypad

RS 485 Modbus for PC programming  
 and device interfacing

Memory key connector

I/O analog / digital

I/O analog / digital

CAN bus  
 Profibus  
 Ethernet  
 EtherCAT

1° feedback sensor

2° feedback sensor

CAN bus Port



Simulated encoder  
 output and motor  
 thermal probes  
 (PTC, NTC, KTY84)

U – V – W motor  
 power + and F braking  
 resistor external

**DIGITAL AND ANALOG I/O**  
 8 configurable digital inputs (opto)  
 2 configurable digital outputs  
 2 relay outputs  
 3 configurable analog inputs  
 2 configurable analog outputs ± 10V  
 1 frequency input (f max 400kHz)  
 1 reference voltage supply ± 10V

## ADVANCED FEATURES

- Output frequency 0 - 1.100 Hz
- Switching frequency (PWM) 3 - 16 kHz
- Speed loop bandwidth 150 Hz (delay 45°)
- Current loop bandwidth up to 1500 Hz (delay 45°)
- Update cycle internal loop: speed, current, positioning and speed task
- PLC cycle equal to the PWM cycle selectable from 3up to 16 kHz (200 - 62,5 microS)
- 3 fast inputs with sampling time 150 MHz

## CARATTERISTICHE AVANZATE

- Frequenza in uscita: 0 - 1.100 Hz
- Frequenza di PWM: impostabile 3 - 16 kHz
- Banda passante anello di velocità 150Hz
- Banda passante anello di corrente 1500 Hz
- Aggiornamento ciclo interno di velocità, corrente, posizione e task
- Ciclo PLC pari al periodo di PWM, selezionabile da 3 a 16 kHz (200 - 62,5 microS)
- 3 ingressi veloci con tempo di campionamento 150 MHz



## DUOBLE FEEDBACK SENSORS

The drive manages 2 feedback sensors: one on the motor and one external. (For applications requiring the compensation of backlash).

- TTL Encoder
- TTL Encoder and Hall sensors
- Resolver
- Sin-Cos encoder (incremental and absolute)
- Endat 2.1 and 2.2 encoder
- Biss encoder

## DOPPIO SENSORE DI RETROAZIONE

Il drive gestisce 2 sensori di feedback: uno sul motore e uno esterno. (Per applicazioni che richiedono la compensazione del gioco meccanico).

- TTL Encoder
- TTL Encoder and Hall sensors
- Resolver
- Sin-Cos encoder (incrementale e assoluto)
- Endat 2.1 and 2.2 encoder
- Biss encoder

## FIELDBUS

The drive manages the fieldbus with two independent lines, one for communication between drive (can bus) and the second for external communication.

- CANopen DSP 402 profile with expandable digital I/O
- Profibus DP
- EtherCAT
- Anybus CC (DeviceNet, Ethernet IP, Sercos etc)

## BUS DI CAMPO

Il drive gestisce il bus di campo con 2 linee indipendenti; una per la comunicazione fra drive (can bus) e la seconda per la comunicazione esterna.

- CANopen profilo DSP 402 con espandibilità I/O digitali
- Profibus DP
- EtherCAT
- Anybus CC (DeviceNet, Ethernet IP, Sercos ecc)

## ADVANCED APPLICATION SW

- Electrical gear
- PID regulator
- Positioner
- Interpolated positioner (CANopen real time DS 301 - DSP 402)
- Electronic cams
- Servodiameter
- Two memory banks
- Spindle indexing
- Encoder management
- Flying and rotary cutter
- Backlash management

## SW APPLICATIVI AVANZATI

- Asse elettrico
- Regolatore PID
- Posizionatore
- Posizionatore interpolato (CANopen real time DS 301 - DSP402)
- Camma elettronica
- Servodiametro
- Due banchi di memoria
- Indexaggio mandrino
- Feedback con encoder fuori asse
- Taglio rotativo e lineare
- Funzione antigiooco

CANopen

Anybus®

PROFI  
BUS

EtherCAT®



**MINI OPD EXP is extremely flexible with the following modes of operation:**

**Inverter: Field Oriented Control – Vector V/F**

**Brushless: With feedback and function weakening area**

AC input power:  
1 phase / 3 phase 110 ÷ 230V ac  
3 phase 230 ÷ 460V ac

Memory key connector

Keypad and display

Frequency output

Relais output

Frequency Input

CAN bus line

RS 485 Modbus for PC programming  
and device interfacing

I/O analog / digital

**DIGITAL & ANALOG I/O**

- 8 digital inputs
- 2 digital outputs
- 3 analog inputs ± 10V
- 2 analog outputs ± 10V
- 1 stabilized supply ± 10V
- 1 relay output
- 1 integrated CANopen line

**FEEDBACK SENSORS**

- TTL Encoder
- TTL Encoder and Hall sensors
- Resolver
- Sin-Cos encoder (incremental and absolute)
- Endat 2.1 and 2.2 encoder
- Biss encoder

U V W motor power connection  
R R for external braking resistor  
DC bus input (280V ÷ 750V)

Feedback options

24Vdc electronic supply  
and motor temperature sensor

Shield cable management



# software OPDEXPLORER

## OPD EXPLORER CONFIGURATION, PROGRAMMING, SUPERVISION, TELEDIAGNOSIS TOOL

Developed under Windows environment HTML, XML, with a control menu divided into folders. It allows the user to configure optmally the drives via PC

Procedure of assistance for the commissioning and parametrization (Wizard) with access to the motors and sensors data base

I/O management.

SoftScope function: digital scope up to 4 values (realtime data sampling and displaying) with settable pre / pos trigger (t sampling = 200 microsec)

Parameters and variables configuration with saving of the settings on both OPDEplorer and programming key

Download and upload management of the parameters, firmware and applications

Window and buffer of drive alarms (code, description and time)

Communication via ModBus (60 units), CAN bus, ProfiBus and EtherCAT

## OPD EXPLORER TOOL DI CONFIGURAZIONE PROGRAMMAZIONE, SUPERVISIONE E TELEASSISTENZA

Sviluppato in ambiente windows HTML, XML, con un intuitivo menù di controllo suddiviso in cartelle, permette di configurare e utilizzare in modo ottimale i drive tramite PC

Procedura di supporto alla messa in funzione e alla parametrizzazione (Wizard) con possibilità di accesso a data base motori e sensori

Gestione di tutti gli I/O

Funzione oscilloscopio: monitoraggio grafico fino a 4 grandezze contemporanee con pre/pos trigger impostabile (t sampling= 200 microsec)

Configurazione di parametri con salvataggio delle impostazioni sia su OPDEplorer che su chiavetta di programmazione

Gestione download e upload sia dei parametri che del firmware e degli applicativi

Visualizzazione e gestione allarmi (codice, descrizione e ora)

Comunicazione tramite ModBus (60 unità), CAN bus, ProfiBus e EtherCAT

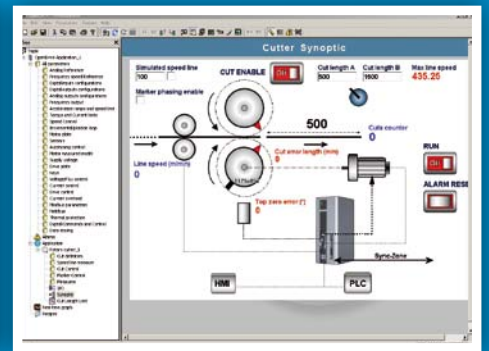
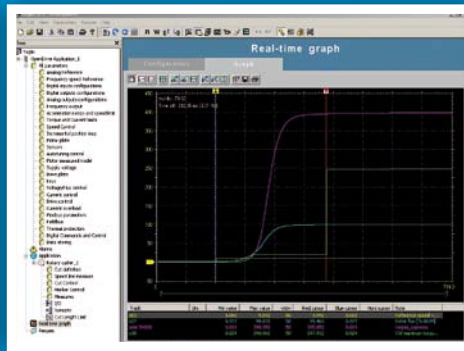
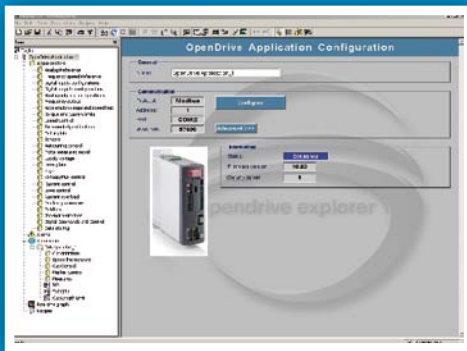

## LOGICLAB PLC ON BOARD FUNCTION AND APPLICATION

The embedded intelligence, according to IEC 61131-3, for developing complex applications

LogicLab is an efficient development environment and particularly user-friendly program

LogicLab is a multiplatform standard IEC 61131-compliant integrated environment for PLC development

It allows to develop applications for automation ,motion control, process control etc (task faster than 200 microS and 100k word of program memory available)

### THE LANGUAGE

LogicLab supports all 5 programming languages of the standard IEC 61131-3

Two testual languages:

IL instruction list  
ST structured text

Three graphic languages:

LD ladder diagram  
FDB function block diagram  
SFC sequential function chart

APPLICATIONS ON THE DRIVE  
LogicLab allows to develop applications (without any limitations) that extend the basic features of the drive:

- Electrical gear
- PID regulator (pumps, fans, winders / unwinders)
- Positioner
- Electronic cams
- Servodiameter
- Spindle indexing
- Encoder management
- Flying and rotary cutter
- Backlash management

LogicLab allows the independent development of applications, ensuring the intellectual property of the project

## PLC ON BOARD LOGICLAB FUNZIONI E APPLICAZIONI

L'intelligenza integrata secondo lo standard IEC 61131-3, per lo sviluppo di applicativi complessi

LogicLab è un potente strumento per lo sviluppo senza limiti di funzioni e applicativi complessi, \*standard IEC 61131-3, direttamente implementabili a bordo di OPD EXP

Permette di sviluppare applicazioni di automazione, motion ecc. con task veloci a 200 micro S e 100 k word di Program memory disponibili

### I LINGUAGGI

LogicLab dispone di 5 linguaggi standard IEC 61131-3, per la programmazione PLC

2 linguaggi testuali

IL instruction list  
ST structured text

3 linguaggi grafici

LD ladder diagram  
FDB function block diagram  
SFC sequential function chart

APPLICAZIONI A BORDO DRIVE

LogicLab permette di sviluppare applicazioni che estendono le caratteristiche di base del drive:

- Asse elettrico
- Regolatore PID (pompe, ventiatori, avvolgitori / svolgitori)
- Posizionatore
- Camma elettronica
- Servodiametro
- Indexaggio mandrino
- Gestione encoder fuori asse
- Taglio rotativo e lineare
- Funzione antigiooco

LogicLab permette lo sviluppo autonomo delle applicazioni, garantendo la proprietà intellettuale del progetto



# **OPD**EXP

## **TDE MACNO**

Tecnologie Digitali Elettroniche S.p.A.

Via dell'Oreficeria, 41

36100 Vicenza - Italy

TEL. +39 0444 343555

FAX. +39 0444 343509

info@tdemacno.it

[www.tdemacno.it](http://www.tdemacno.it)

