

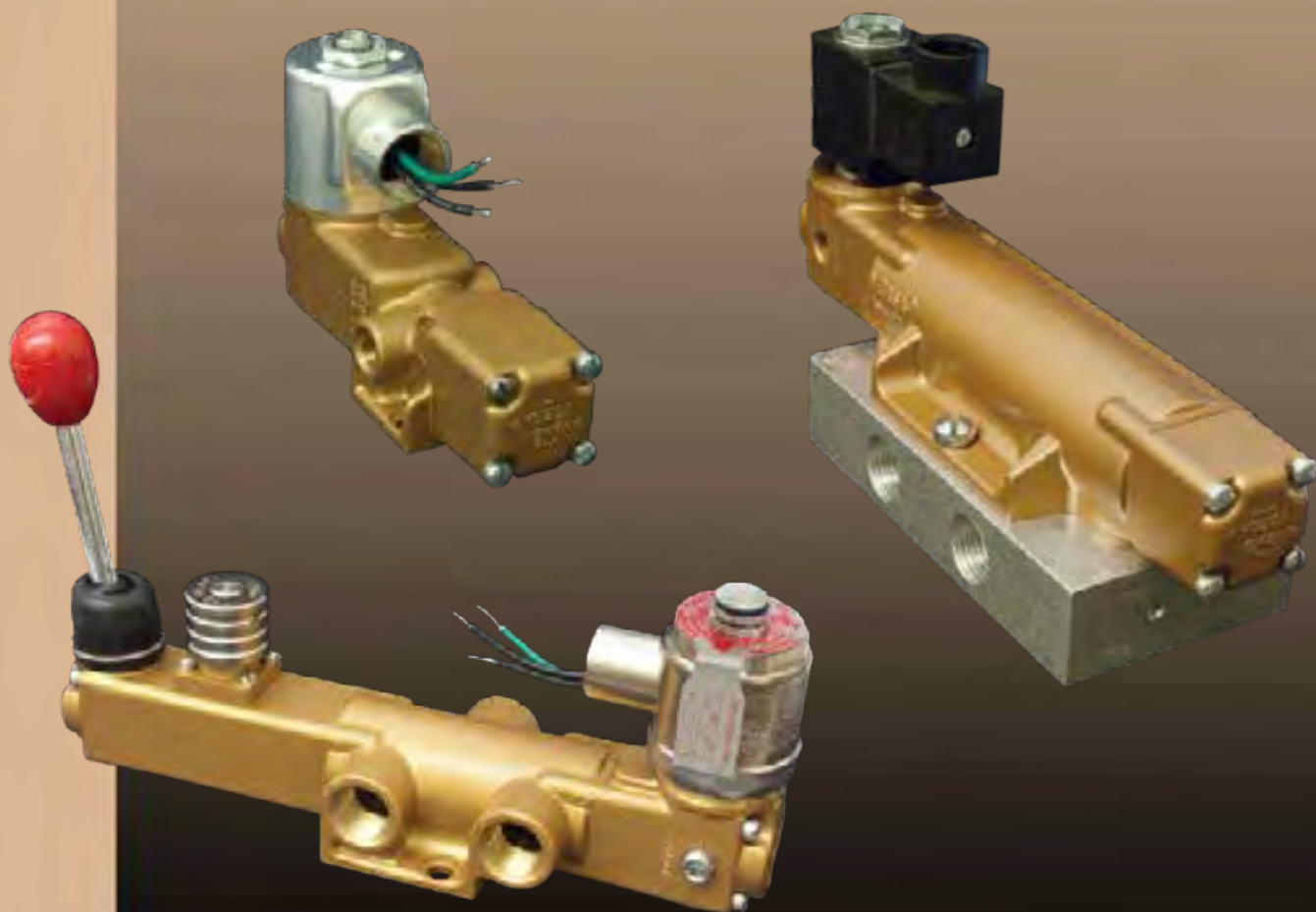

Bulletin: VT
2017

V & T SERIES



QUICK INDEX

VALVES/ACTUATORS	Section	Page
Two-Way Valves	general	V 2-WAY 18
.....	dimensions	V 2-WAY 20
.....	subplates & manifolds	V 2-WAY 24
Three-Way Valves	general	V 3-WAY 26
.....	dimensions	V 3-WAY 28
.....	subplates & manifolds	V 3-WAY 32
Four-Way Valves	general	V 4-WAY 34
.....	dimensions	V 4-WAY 36
.....	subplates & manifolds	V 4-WAY 40
Five-Way Valves	general	V 5-WAY 42
(Dual Pressure	dimensions	V 5-WAY 44
Four-Way)	subplates & manifolds	V 5-WAY 48
Actuating Devices		14-17
Latching-Manual Reset Valves		68
Lockout Valves		65
“Oil-Free Service” Valves		70
Redundant Solenoid Valves		66
Stainless Steel Tag		71
SPECIFICATIONS		
Basic Features		3
Construction		4
Electrical		8-11
Filtration		4
Flow (Cv)		5
Lubrication		4
Port Sizes		5
Pressure Ranges		6
Product Numbering System		12-13
Seals		4
Temperature		7
Valve Sizing		5
PARTS		
Actuator Subassemblies.....		56
Body Subassemblies		50
Combination Actuators		62
Repair Kits		71
WARNINGS & WARRANTY		Back Cover

BASIC FEATURES

Versa exercises diligence to assure that information contained in this catalog is correct, but does not accept responsibility for any errors or omissions. Versa also reserves the right to change or delete data or products at any time without prior notification. To be sure the data you require is correct, consult factory.

GENERAL CHARACTERISTICS OF SERIES "V" & "T" VALVES

VERSATILITY: For practically all pneumatic, and for many low pressure hydraulic directional control applications there is a Versa Valve made for trouble-free performance under the most exacting conditions. Integrity of design makes Versa Valves adaptable to a maximum number of applications with a minimum of components. This is possible through the modular approach to valve construction, which allows valve bodies and actuating devices to be interchanged end for end and valve for valve in many cases. The next few pages illustrate the modular approach to valve design and how this makes possible the many thousands of viable valving variations with Versa's Series "V" & "T" valves. A logical, significant product numbering system, derived from the modular method, enables the customer to "build" his own valve to fit his unique specifications.

CONSTRUCTION:

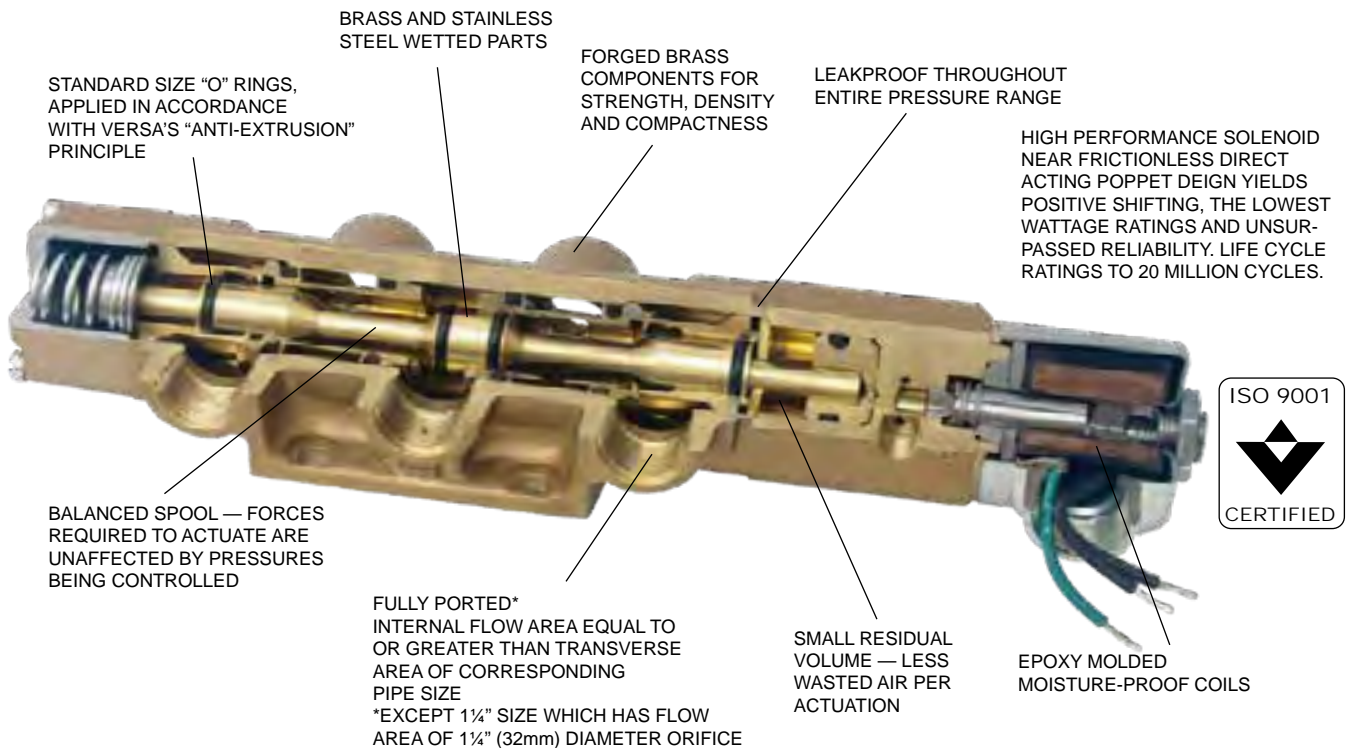

EVERY VALVE FUNCTIONALLY TESTED THROUGHOUT COMPLETE PRESSURE RANGE BEFORE SHIPPING

COMPATIBILITY & APPLICATION RANGE: Series "V" valves are designed for the control of pneumatic pressures from partial vacuum to 200 psi (14 bar). However, the use of standard O ring seals makes it possible to supply many different compounds in order to meet varying conditions of media and temperature. In general, the standard NBR (Nitrile) O rings used in Series "V" valves allow application for most general industrial use. Ambient temperatures below freezing require moisture free air and the use of suitable lubrication.

Series "T" valves are designed for the control of hydraulic pressures 0 to 500 psi (35 bar). Their maximum media temperature is 130°F (55°C). For water service, consult factory.

Limitations generally apply to specific types of actuation, such as solenoid or pilot. The minimum and maximum pressures in these cases are dependent upon valve size, method of return actuation, valve series, range of pressure being controlled. For specific information refer to specification pages 3 thru 13.

Specifications

CONSTRUCTION

Materials of construction:

Body	Forged Brass
Internal Parts (wetted)	Brass [with electrical nickel plated (-10)] or stainless steel
Spring Cap	Diecast aluminum (std), Forged brass (optional)
Manual Knobs	Plastic
Pedal or Treadle	Aluminum casting
Subplates & Manifolds	Aluminum (std) – Brass (optional)
Fasteners	Steel (std), Stainless Steel (optional)
Seals	NBR (Nitrile) (std), FKM (fluorocarbon) -155 EPR (ethylene propylene) -EP TFE (tetrafluoroethylene) For hydraulic applications over 100 psi

FILTRATION & LUBRICATION

VERSA Series “V” & “T” valves are lubricated during assembly to insure that the valve will operate to specifications. An FRL with 40-50 microns filter is recommended. Where continued lubrication is not possible, consult factory.

Listed below is a are of commercially available light (turbine type) oils which are recommended for Series “V” valves. They are compatible with the seals normally used.

Airline Lubricator Oils

Manufacturer	Lubricant
Chevron Oil Co.	GST Oil 32
CITGO	Pacemaker T-32
Exxon	Teresstic 32
Gulf Oil Corp	Harmony 32
Mobil Oil Corp.	DTE Light
Shell Oil Co	Turbo 32
Sun Oil Co	Sunvis 932
Texaco Inc	Regal Oil R & O 32

Specifications

PORT SIZES (Valve or Sub-plate)

PORT NAME	VALVE SIZE							
	1/8	1/4	3/8	1/2	3/4	1	1-1/4 (sideported)	1-1/4 (subplate mounting)
Inlet, Cylinder, Outlet, Exhaust	1/8" NPT or G	1/4" NPT or G	3/8" NPT or G	1/2" NPT or G	3/4" NPT	1" NPT	1" NPT	1-1/4" NPT
Pilot (Remote or Bleed Type) or EXPilot (Solenoid EXPilot Type)	1/8" NPT							
Pilot (Diaphragm Actuated Type) or Threaded Solenoid Exhaust Adapter (-H)	1/4" NPT							
Solenoid Exhaust	5/16" - 18							

FLOW

The amount of flow through a valve is dependent upon the differential pressure (ΔP) between ports of the valve. Temperature, specific gravity, and viscosity are other variables that can affect flow. When dealing with gases, unless conditions are far from standard, temperature and specific gravity (SG) will have little effect.

Flow is often expressed in terms of C_v . The C_v factor (flow factor) is a mathematical term that defines the relationship between flow and pressure. The larger the C_v factor, the greater the flow capacity of the valve. If the C_v factor, for a particular valve or other component or system is known, it can be substituted into an equation that will give the flow when details about the pressure are known. In the case of gases, it is necessary to know both the outlet pressure and the pressure drop (or at least an approximation) in order to determine the flow.

C_v factors may be used to compare one valve's flow capacity with another. However, bear in mind that latitude exists for valve manufacturers to determine the C_v factor and therefore this kind of comparison may not be entirely valid.

GASES

$$SCFM = 22.5 C_v \sqrt{\frac{\Delta P \text{ (Outlet psi abs)}}{(460^\circ + F^\circ) (SG)}}$$

LIQUIDS

$$GPM = C_v \sqrt{\frac{\Delta P \text{ psi}}{(SG)}}$$

C_v FACTORS FOR SERIES "V" & "T" VALVES

Basic Valve Size	Flow Area Diameter	Port Size*	Average	FLOW**	
			C_v Factor (all ports)	SCFM	NM ³ /H
1/4	3/8" (9.5mm)	1/8" NPT or G	1.4	80	145
		1/4" NPT or G	1.8	100	185
1/2	5/8" (15.9mm)	3/8" NPT or G	3.4	200	345
		1/2" NPT or G	4.0	240	405
1	1-1/16" (26.99mm)	3/4" NPT	9.7	580	980
		1" NPT	11.1	640	1125
1-1/4	1-1/4" (31.75mm)	1" NPT (side ported)	14.9	890	1820

* Subplates of the same port size will provide C_v factors 5-10% lower. Over-ported subplates can be supplied which will usually increase the C_v factor 5-10%. Fittings with smaller ID than the corresponding iron pipe will restrict flow.

**Assumptions:
Flow = air
Inlet pressure = 100 psi (7 bar)
 ΔP = 40 psi (3 bar)
Outlet abs = 74.7 psi (5 bar)
Temp = 68°F (20°C)
SG = 1.0

HOW TO SIZE THE VALVE TO THE CYLINDER

In selecting the right valve for a cylinder application, one needs to know three design conditions: 1. Cylinder bore; 2. Stroke; 3. Extension Time. Using the valve selection chart below one can select the smallest valve that will meet the design conditions. The smaller valve generally costs less and requires less space. The valve sizes shown are Series "V" basic sizes; use plumbing of the same capacity for maximum cylinder speed.

MINIMUM PISTON SPEED IN IN/SEC (MM/SEC)

CYLINDER BORE IN INCHES (mm)	1 (25.4)	3 (76.2)	6 (152.4)	12 (304.8)	24 (609.6)	36 (914.4)	48 (1219.2)
Thru 2" (50.8)							
Thru 2-1/2" (63.5)							
Thru 4" (101.6)	1/4" Basic Size						
Thru 5" (127.0)	1/2" Basic Size						
Thru 6" (152.4)	1" Basic Size						
Thru 8" (203.2)	1 1/4" Basic Size						

This table was derived from extensive valve-performance testing with a wide variety of cylinders. It is based on short line [air travels at approximately 1,000 feet (305 meters) per second], 60-90 psi (4.1-6.2 bar) at the valve, cycle rates of 60 cpm or less, small difference in effective area, equal inlet and exhaust C_v factors, and loads requiring less than 30 psi (2.1 bar) to initiate movement. In other cases, an experimental approach must be used.

Specifications

PRESSURE RANGES

SERIES "V" Pneumatic*

TYPE OF ACTUATION	TYPE OF RETURN	OPERATING PRESSURE RANGE THROUGH VALVE (CONTROLLED PRESSURE)		MINIMUM PILOT PRESSURE ^{††} (When Applicable)		
		1/8 - 1/2	3/4 - 1 (1 1/4 ^{**})	1/8 - 1/2	3/4 - 1 1/4	
CAM, PEDAL, TREADLE or HAND	Spring, Spring Centering, Detent, Cam, Treadle, Pedal, Hand	VAC. - 200 psi (VAC. - 14 bar)	VAC. - 200 psi (VAC. - 14 bar)			
PILOT	Pressure Pilot	Spring, Spring Centering	VAC. - 200 psi (VAC. - 14 bar)	VAC. - 200 psi (VAC. - 14 bar)	40 psi (2.8 bar)	50 psi (3.5 bar)
		Pressure Pilot	VAC. - 200 psi (VAC. - 14 bar)	VAC. - 200 psi (VAC. - 14 bar)	20 psi (1.4 bar)	20 psi (1.4 bar)
	Bleed Pilot	Bleed Pilot	40 - 200 psi (2.8 - 14 bar)	40 - 200 psi (2.8 - 14 bar)		
	Diaphragm	Spring, Spring Centering		VAC. - 200 psi (VAC. - 14 bar)		15 - 50 psi MAX (1 - 3.5 bar MAX)
			-31	VAC. - 200 psi (VAC. - 14 bar)	VAC. - 200 psi (VAC. - 14 bar)	10 - 200 psi MAX (0.7 - 14 bar MAX)
		Diaphragm		VAC. - 200 psi (VAC. - 14 bar)		6 - 50 psi MAX (0.4 - 3.5 bar MAX)
	-31	VAC. - 200 psi (VAC. - 14 bar)	VAC. - 200 psi (VAC. - 14 bar)	5 - 200 psi MAX (0.3 - 14 bar MAX)	20 - 200 psi MAX (1.4 - 14 bar MAX)	
SOLENOID - † PILOT	INPilot	Spring, Spring Centering	40 - 175 psi [†] (2.8 - 12 bar) [†]	40 - 175 psi [†] (2.8 - 12 bar) [†]		
		Solenoid Pilot	20 - 175 psi [†] (1.4 - 12 bar) [†]	20 - 175 psi [†] (1.4 - 12 bar) [†]		
	EXPilot	Spring, Spring Centering	VAC. - 200 psi [†] (VAC. - 14 bar) [†]	VAC. - 200 psi [†] (VAC. - 14 bar) [†]	40 - 175 psi MAX [†] (2.8 - 12 bar MAX) [†]	50 - 175 psi MAX [†] (3.5 - 12 bar MAX) [†]
		Solenoid Pilot	VAC. - 200 psi [†] (VAC. - 14 bar) [†]	VAC. - 200 psi [†] (VAC. - 14 bar) [†]	20 - 175 psi MAX [†] (1.4 - 12 bar MAX) [†]	20 - 175 psi MAX [†] (1.4 - 12 bar MAX) [†]

* The standard V Series product is rated for air and gas service including natural gas. While the standard valve is rated for natural gas, Versa recommends suffix detail -NGS for enhanced valve performance (-NGST for low temperature applications). For other gases please consult factory for seal compatibility.

** For 1 1/4" maximum operating pressure is limited to 150 psi (10 bar), pneumatic.

† All standard solenoid valves with maximum operating pressure or pilot pressure listed at 175 psi (12 bar) may be plus pressure rated to a maximum of 200 psi (14 bar). Specified by adding suffix -200 to model number.

†† Minimum Pilot Pressures are based on normal airline lubrication. For more prolonged and efficient operating life, use an airline filter and lubricator device. Refer to Page 7 for recommendations. Where lubrication is not possible, consult the factory for required modifications.

SERIES "T" (Hydraulic) †††

TYPE OF ACTUATION	TYPE OF RETURN	OPERATING PRESSURE RANGE THROUGH VALVE (CONTROLLED PRESSURE)		MINIMUM PILOT PRESSURE ^{††} (When Applicable)		
		1/8 - 1/2	3/4 - 1	1/8 - 1/2	3/4 - 1	
CAM, PEDAL, TREADLE or HAND	Spring, Spring Centering, Detent, Cam, Treadle, Pedal, Hand	0 - 500 psi (0 - 35 bar)	0 - 500 psi (0 - 35 bar)			
PILOT	Pressure Pilot	Spring, Spring Centering	0 - 500 psi (0 - 35 bar)	0 - 500 psi (0 - 35 bar)	55 psi (3.8 bar)	55 psi (3.8 bar)
		Pressure Pilot	0 - 500 psi (0 - 35 bar)	0 - 500 psi (0 - 35 bar)	30 psi (2.1 bar)	40 psi (1.4 bar)
	Bleed Pilot	Bleed Pilot	55 - 500 psi (3.8 - 35 bar)	55 - 500 psi (3.8 - 35 bar)		
	Diaphragm	Spring, Spring Centering		0 - 500 psi (0 - 35 bar)		20 - 50 psi MAX (1.4 - 3.5 bar MAX)
			-31	0 - 500 psi (0 - 35 bar)	0 - 500 psi (0 - 35 bar)	15 - 200 psi MAX (1 - 14 bar MAX)
		Diaphragm		0 - 500 psi (0 - 35 bar)		10 - 50 psi MAX (0.7 - 3.5 bar MAX)
	-31	0 - 500 psi (0 - 35 bar)	0 - 500 psi (0 - 35 bar)	8 - 200 psi MAX (0.6 - 14 bar MAX)	25 - 200 psi MAX (1.7 - 14 bar MAX)	
SOLENOID - PILOT	INPilot	Spring, Spring Centering	55 - 175 psi (3.8 - 12 bar)	55 - 175 psi (3.8 - 12 bar)		
		-H500	125 - 450 psi (8.6 - 31 bar)	125 - 450 psi (8.6 - 31 bar)		
	Solenoid Pilot		30 - 175 psi (2.1 - 12 bar)	40 - 175 psi (2.1 - 12 bar)		
		-H500	70 - 450 psi (4.8 - 31 bar)	70 - 450 psi (4.8 - 31 bar)		
	EXPilot	Spring, Spring Centering	0 - 500 psi (0 - 35 bar)	0 - 500 psi (0 - 35 bar)	55 - 175 psi MAX (3.8 - 12 bar MAX)	55 - 175 psi MAX (3.8 - 12 bar MAX)
	Solenoid Pilot	0 - 500 psi (0 - 35 bar)	0 - 500 psi (0 - 35 bar)	30 - 175 psi MAX (2.1 - 12 bar MAX)	40 - 175 psi MAX (2.8 - 12 bar MAX)	

††† For water service consult factory Product Bulletin 132.

Specifications

SOLENOID/PILOT — SPECIFICATIONS

TEMPERATURE

O RING, COIL, & SOLENOID PLUNGER RECOMMENDATIONS FOR AVERAGE SERVICE CONDITIONS AT VARIOUS TEMPERATURES

Temperature Range Medium/Ambient Temperature	O Ring Seals † (All Valves) **	Solenoid Plungers & Coils for Electrical Service					
		Intermittent Duty		Continuous Duty (Dead End Service)			
		AC or DC Service		AC Service		DC Service	
		Coil	Solenoid Plunger	Coil	Solenoid Plunger	Coil	Solenoid Plunger
Above 300°F (150°C)	Valves not recommended	Valves not recommended		Valves not recommended		Valves not recommended	
200°F to 300°F (95°C to 150°C)	Suffix -155	Valves not recommended		Valves not recommended		Valves not recommended	
150°F to 200°F (65°C to 95°C)	Suffix -155	Suffix -HT	Suffix -3 (which is included in coil suffix -HT)	Suffix -HT	Suffix -3 (which is included in coil suffix -HT)	Suffix -HT *	Suffix -3 (which is included in coil suffix -HT)
120°F to 150°F (50°C to 65°C)	Standard NBR (nitrile) NBR (high nitrile)-(Suffix -11) FKM (fluorocarbon)-(Suffix -155)	Standard*	Suffix -3	Standard	Suffix -3	Suffix -HT *	Suffix -3 (which is included in coil suffix -HT)
20°F to 120°F (-5°C to 50°C)	Standard NBR (nitrile) NBR (high nitrile)-(Suffix -11) FKM (fluorocarbon)-(Suffix -155)	Standard	Standard	Standard	Suffix -3	Standard	Suffix -3
5°F to 20°F (-15°C to -5°C)	Standard NBR (nitrile) NBR (high nitrile)-(Suffix -11) FKM (fluorocarbon)-(Suffix -155)	Standard	Standard	Standard	Suffix -3	Standard	Suffix -3
-40°F (-40°C) to +200°F(+93°C)	Low temperature NBR (nitrile), Compound MS29513/MIL-P-53153, (Suffix -44)		Low Temp		Low Temp		Low Temp
-60°F (-51°C) To maximum, based on coil type and agency approvals	Ethylene-Propylene (EPR) (Suffix -EP)		-EP		-EP		-EP

* At elevated temperature in DC service the coil develops less power because resistance increases. Consult Factory with application details.

** O ring seals in the table refers only to dynamic seals. Occasionally it is necessary to change static seals due to temperature or chemical requirements.

† SERIES T: Dynamic seals are a combination of TFE (tetrafluoroethylene) and NBR (nitrile). Only the NBR (nitrile) rings can be changed. Temperature range of Series T valves is 32°F to 130°F (0°C to 55°C).

This guide is designed for evaluation by technically competent persons and is thought to be reliable, but Versa Products Co., Inc. shall have no responsibility or liability for the results obtained or damages resulting from such use.

Specifications

SOLENOID/PILOT — SPECIFICATIONS

COIL COVER — Standard provides 1/2" NPT female conduit connection.

Use Suffix –243 for grommeted housing with wire leads.

Use Suffix –HC or –HCC for DIN style coil connector.

COILS — Standard coil lead lengths are at least 24" (60cm). Consult factory for availability of longer lead lengths

CONTINUOUS DUTY COIL VOLTAGES*

SERIES	SOLENOID OPERATOR (Service & Type)		AC					DC								
			Voltage	Coil Code #	Inrush Amp	Holding Amp	Ohm	Voltage	Coil Code#	Amp-Inrush & Holding	Ohm					
V & T	ORDINARY or HAZARDOUS	Standard, Suffix -243, Suffix -P, Suffix -XX	24/60	A024	1.30	0.82	6	6 12 24 48 125	D006 D012 D024 D048 D125	1.54 0.78 0.38 0.19 0.08	4 16 63 249 1675					
			120/60	A120	0.26	0.16	146									
			240/60	A240	0.13	0.08	593									
			480/60	A480	0.07	0.04	2365									
			24/50	E024	1.05	0.67	9									
			110/50	F120	0.23	0.15	193									
			230/50	E230	0.11	0.07	700									
			240/50	E240	0.11	0.07	876									
		ORDINARY DIN	Suffix -HC or -HCC	120/60	A120	0.20	0.16					205	12 24 48	D012 D024 D048	0.86 0.44 0.21	14 55 225
				240/60	A240	0.13	0.08					845				
110/50				E110	0.20	0.16	205									
220/50				E220	0.13	0.08	845									
HAZARDOUS		[(d) Flameproof]	Low Watt Suffix -3567 Suffix -3567 -LB-XN	12/60	A012	0.58	0.30	11	6 12 24 48 120	D006 D012 D024 D048 D120	0.32 0.16 0.08 0.04 0.02	19 75 312 1337 7815				
				24/60	A024	0.20	0.15	43								
				48/60	A048	0.14	0.07	175								
				120/60	A120	0.06	0.03	1085								
				240/60	A240	0.03	0.02	5050								
[(d) Flameproof] [(e) Increased Safety]		Suffix -XDBS** or -XDBT**	120/60	A120				12 24 48 110 220	D012 D024 D048 D110 D220							
			240/60	A240												
			110/50	E110												
			220/50	E220												
**For XDAT & XDAS consult factory																
[(d) Flameproof]		Suffix -XN	24/60	A024	0.63	0.38	19	6 12 24 48 125	D006 D012 D024 D048 D125	1.30 0.63 0.32 0.16 0.06	5 19 295 2030					
			120/60	A120	0.13	0.08	475									
			240/60	A240	0.06	0.04	2000									
			24/50	E024	0.61	0.37	25									
			110/50	E110	0.13	0.08	475									
			220/50	E220	0.07	0.04	2030									
[(ia) Intrinsic Safe]	Suffix -HC-XISC, -HCC -XISC Suffix -HC-XISX6, -HCC -XISX6 Suffix -XIFA, -XIFE, -XIFF	—	—	—	—	—	24	D024	—	—						
		—	—	—	—	—										
		—	—	—	—	—										
[(m) Encapsulation] [(e) Increased Safety]	Suffix -XMFA, -XMFE -XMFF, -XMFG Suffix -XMAA, -XMAE, -XMAF, -XMAG	—	—	—	—	—			—	—						
		—	—	—	—	—										

* Coils for voltages other than those listed above, may be available.
Class H (Suffix –HT) coils are available for both ordinary and hazardous service.
Contact factory for availability and delivery information.

Specifications

HAZARDOUS LOCATION COMBINATION SUFFIX DETAILS

Suffix Reference	
Suffix	Description
-CD	72" wire leads
-D14	Solenoid vent, water proof nut
-H2E	1/8" npt Solenoid vent
-HE	¼" npt Solenoid vent
-HT	Class H coil
-L14	Solenoid vent dust nut
-LA	0.85 watt Solenoid
-LB	1.8 watt Solenoid
-LV	0.85 watt (World Solenoid)
-LX	1.8 watt (World Solenoid)
-LZ	0.5 watt (World Solenoid)
-PC	Potted coil; NEMA 4
-PS	Potted coil, male conduit;
-ST	Stainless Solenoid housing
-VJBT	Add on Junction Box
-XDB	World Solenoid; NEMA 4/IP67
-XN	ATEX Solenoid
-XT	World Solenoid; NEMA 4/IP67
-XV	World Solenoid; NEMA 4/IP67
-XX	North American Solenoid
-303D	Integral diode

North American (-XX) (Cont.)	
Combination Suffix	Included Suffix
-XXK	-XX, -HT, -LB, -PC, -ST
-XXK4	-XX, -D14, -HT, -LB, -PC, -ST
-XXL	-XX, -PC
-XXL4	-XX, -D14, -PC
-XXM	-XX, -HT, -PC
-XXM4	-XX, -D14, -HT, -PC
-XXN	-XX, -LB, -PC
-XXN4	-XX, -D14, -LB, -PC
-XXQ	-XX, -HT, -LB
-XXQ4	-XX, -D14, -HT, -LB
-XXR	-XX, -LB
-XXR4	-XX, -D14, -LB
-XXS	-XX, -LA, -ST
-XXS4	-XX, -D14, -LA, -ST
-XXU	-XX, -HT, -LB, -ST
-XXU4	-XX, -D14, -HT, -LB, -ST
-XXV	-XX, -LA
-XXV4	-XX, -D14, -LA
-XXW	-XX, -CD, -HT, -H2, -PC, -ST
-XXW4	-XX, -D14, -CD, -HT, -PC, -ST

ATEX (-XN) (cont.)	
Combination Suffix	Included Suffix
-XNR	-XN, -LB
-XNS	-XN, -LA, -ST
-XNU	-XN, -HT, -LB, -ST
-XNV	-XN, -LA
-XNX	-XN, -LB, -PS
-XNWS	-XN, -VJBT, -LB, -PS

World Solenoid (-XDB, -XV, -XT)	
Combination Suffix	Included Suffix
-XDBS1	-XDBS, -HT, -LX
-XDBS2	-XDBS, -HT, -LX, -H2E
-XDBS3	-XDBS, -HT, -LX, -HE
-XDBS4	-XDBS, -HT, -LX, -L14
-XDBS5	-XDBS, -HT, -LX, -303D
-XDBS6	-XDBS, -HT, -LX, -H2E, -303D
-XDBS7	-XDBS, -HT, -LX, -HE, -303D
-XDBS8	-XDBS, -HT, -LX, -L14, -303D
-XDBS9	-XDBS, -HT, -LX, -D14
-XDBS10	-XDBS, -HT, -LX, -D14, -303D
-XDBT1	-XDBT, -HT, -LX
-XDBT2	-XDBT, -HT, -LX, -H2E
-XDBT3	-XDBT, -HT, -LX, -HE
-XDBT4	-XDBT, -HT, -LX, -L14
-XDBT5	-XDBT, -HT, -LX, -303D
-XDBT6	-XDBT, -HT, -LX, -H2E, -303D
-XDBT7	-XDBT, -HT, -LX, -HE, -303D
-XDBT8	-XDBT, -HT, -LX, -L14, -303D
-XDBT9	-XDBT, -HT, -LX, -D14
-XDBT10	-XDBT, -HT, -LX, -D14, -303D
-XV1	-XV, -HT, -LX
-XV2	-XV, -HT, -LX, -H2E
-XV3	-XV, -HT, -LX, -HE
-XV4	-XV, -HT, -LX, -L14
-XV9	-XV, -HT, -LX, -D14
-XT1	-XT, -HT, -LX
-XT2	-XT, -HT, -LX, -H2E
-XT3	-XT, -HT, -LX, -HE
-XT4	-XT, -HT, -LX, -L14
-XT9	-XT, -HT, -LX, -D14

North American (-XX)	
Combination Suffix	Included Suffix
-XXA	-XX, -HT
-XXA4	-XX, -D14, -HT
-XXB	-XX, -PS
-XXB4	-XX, -D14, -PS
-XXC	-XX, -HT, -PS
-XXC4	-XX, -D14, -HT, -PS
-XXD	-XX, -ST
-XXD4	-XX, -D14, -ST
-XXE	-XX, -PC, -ST
-XXE4	-XX, -D14, -PC, -ST
-XXF	-XX, -HT, -ST
-XXF4	-XX, -D14, -HT, -ST
-XXG	-XX, -LB, -ST
-XXG4	-XX, -D14, -LB, -ST
-XXH	-XX, -HT, -PC, -ST
-XXH4	-XX, -D14, -HT, -PC, -ST
-XXJ	-XX, -LB, -PC, -ST
-XXJ4	-XX, -D14, -LB, -PC, -ST

ATEX (-XN)	
Combination Suffix	Included Suffix
-XNA	-XN, -HT
-XND	-XN, -ST
-XNE	-XN, -PC, -ST
-XNE4	-XN, -D14, -PC, -ST
-XNF	-XN, -HT, -ST
-XNG	-XN, -LB, -ST
-XNH	-XN, -HT, -PC, -ST
-XNJ	-XN, -LB, -PC, -ST
-XNJ4	-XN, -D14, -LB, -PC, -ST
-XNK	-XN, -HT, -LB, -PC, -ST
-XNL	-XN, -PC
-XNL4	-XN, -D14, -PC
-XNM	-XN, -HT, -PC
-XNN	-XN, -LB, -PC
-XNN4	-XN, -D14, -LB, -PC
-XNP	-XN, -HT, -LB, -PC
-XNQ	-XN, -HT, -LB

Recommended Hazardous Location Solenoid Option Packages

Enclosure/Wire	Certification/Power			
	North American - CSA		ATEX - IECEx - INMETRO	
	Standard Power	Low Watt*	Standard Power	Low Watt*
Steel, Electroless Nickel Plated, 24 Inch Leads	-XXL4	-XXN4	-XNL4	-XNN4
Stainless Steel, High Performance 430 type, 24" wire leads	-XXE4	-XV9	-XNE4	-XT9
Stainless Steel, 316L type, Junction Box with Terminal Strip	—	-XDBT9**	—	-XDBS9

*1.8 watt solenoid. Also available 0.5 and 0.85 watt. Consult factory for availability.



**All the -XDBT type solenoids are "World Solenoids." Certified for North America, ATEX, IECEx and INMETRO and more.

For complete solenoid specifications please see above and page 6-8.

SOLENOID PILOT – ELECTRICAL OPERATOR SPECIFICATIONS

Solenoid/Pilot actuated Series V & T valves are available with a variety of different solenoids for both nonhazardous and hazardous locations. Basic details of actuators are listed below. For additional data consult factory.

Non Hazardous Location Solenoids

	Suffix	Protection Classification	Area Classification and (Gas Grouping)	Agency Approvals	Ingress Protection
	None or -U	General Purpose	Indoor & Outdoor	CSA	NEMA 1,2,3
	-HC -HCC (Shown)	General Purpose	Indoor & Outdoor	—	NEMA 4; IP65

Hazardous Location Solenoids

Agency Approvals		North America 		World*   		
Suffix*	Protection Classification	Zones	Divisions	Area Classification and (Gas Grouping)	Agency	Ingress Protection
	-XX	—	CL I, DIV 1, Grp (C & D) CL II, DIV 1, Grp (E, F & G) Temp T3C	—	UL CSA	NEMA 7 & 9
	-XX		CL I, DIV 2 Grp (A B C) CL II, DIV 2 Grp (E, F & G) Temp T3C			
	-XN	(d) Flameproof	—	Ex d IIB+H2 T3...T6 Gb II 2 G Ex d IIB+H2 T3...T6 Gb	IECEX ATEX	IP66/67
	-XV	Hazardous Locations	—	—	CSA _{US}	NEMA 4, 4X, 6P, IP66
	-XT	(d) Flameproof	CL I, DIV 1, Grp (B, C, D) CL II, DIV 1, Grp (E, F, G) CL III CL I, DIV 2, Grp (A, B, C, D) CL II, DIV 1, Grp (E, F, G) CL III	Ex II 2 G D A/Ex d e IIC T3...T6 Gb Ex tb IIIC T3...T6 Db	ATEX - IECEX INMETRO	IP66/67/68
	-XDBT	(d) Flameproof (e) Increased Safety	CL, I, Zn 1 A/Ex de IIC T* CL, II Zn, 21 AExtD A21, DIP A21			
	-XDBS		—			
	-XMAA -XMAF	(mb) Encapsulation	—	Ex e mb IIC T5, T6 Gb Ex tb IIIC T85°C, T100°C Db II 2 G Ex e mb IIC T5...T6 Gb II 2 D Ex tb IIIC T85°C...T100°C Db	IECEX TR CU ATEX	IP67
	-XMFA -XMFF	(e) Increased Safety (tD) Tight Dust				
	-XIFA -XIFF	(ia) Intrinsic Safe	—	Ex (ia) IIC T4...T6 Gb Ex (ia) IIIC T130°C...T80°C Db II 2 G Ex ia IIC T4...T6 II 2 D Ex iaD 21 T130°C, T80°C	IECEX TR CU ATEX	IP67
	-XISX6	Intrinsic Safe	—	II 2 G Ex ia IIC T4...T6 Gb II 2 G Ex ia IIB T4...T6 Gb	ATEX IECEX TR CU	IP65
	-XISC		—	CL I, DIV 1, Grp (A, B, C & D) CL II, DIV 1, Grp (E, F, & G) CL III	—	

*For additional suffix options see page 9

COIL CODES: Identify the solenoid frequency and voltage, consisting of a "Rating Code" and "Voltage" as shown at right. Coil codes complete the part number for a solenoid operated valve.

Rating Code
 A = 60Hz frequency
 D = Direct Current (DC)
 E = 50Hz frequency

Voltage
 Indicated by three digits:
 e.g. 24 volts = 024
 120 volts = 120

A120 = AC, 120Volts/60hz

	Voltage (Power)	Electrical Characteristics	Miscellaneous
	All usual 50 Hz & 60 Hz AC (7.3W) All usual DC (9.5W)	Class F epoxy molded coil (155°C). Continuous duty, 2 leads 24" (60 cm).	Steel cover with 1/2 NPT conduit entry.
	24V60, 120V60, 240V60 (8.5W) 24V50, 110V50, 220V50 (8.5W) 12VDC, 24VDC, 48VDC (10.5W)	Class F epoxy molded coil (155°C), with 3 spade terminals and mini DIN socket with PG9 cable gland. Continuous duty.	Spade terminals (3) (18mm) Connector: ISO DIN 43650, Form "A" PG9 cable gland (-HC) 1/2" NPT conduit hub (-HCC)

	Voltage (Power)	Electrical Characteristics	Miscellaneous
	50 Hz & 60 Hz AC (7.3W), DC (9.5W) AC: 12V60, 24V60, 48V60, 120V60, 240V60 DC: 6VDC, 12VDC, 24VDC, 48VDC	Class F epoxy molded coil (155°C). continuous duty. 3 leads 24" (60 cm).	Plated steel coil housing with 1/2 NPT conduit entry. For additional solenoid options see pages 9 - 11
	50 Hz & 60 Hz AC (6W), DC (7.2W) & (1.8W) AC: 12V60 (A012), 24V60 (A024), 48V60 (A048), 120V60 (A120), 240V60 (A120) DC: 6VDC (D006), 12VDC (D012), 24VDC (D024), 48VDC (D048)		
			Plated steel coil housing with M20 x 1.5 conduit entry. Ground terminal on cover. For additional solenoid options see pages 9 - 11

	AC: 120V60HZ (A120), 240V60HZ (A240) 110V50HZ (E110), 220V50HZ (E230) DC: 12VDC (D012), 24VDC (D024) 48VDC (D048), 120VDC (D120) 1.8 watt standard. For 0.85 watt consult factory.	Epoxy molded coils rated for continuous duty, Class H – 180°C.	<table border="1"> <thead> <tr> <th></th> <th colspan="2">Suffix Detail Ordering Code</th> </tr> </thead> <tbody> <tr> <td>Stainless steel coil housing</td> <td>XV</td> <td>XT</td> </tr> <tr> <td></td> <td colspan="2">1.8 watt</td> </tr> <tr> <td>Standard (vent to atmosphere)</td> <td>-XV1</td> <td>-XT1</td> </tr> <tr> <td>1/8" Adapter (-H2E)</td> <td>-XV2</td> <td>-XT2</td> </tr> <tr> <td>1/4" Adapter (-HE)</td> <td>-XV3</td> <td>-XT3</td> </tr> <tr> <td>Dust Nut (-L14)</td> <td>-XV4</td> <td>-XT4</td> </tr> <tr> <td>Water proof nut (-D14)</td> <td>-XV9</td> <td>-XT9</td> </tr> </tbody> </table> <table border="1"> <thead> <tr> <th></th> <th colspan="4">Suffix Detail Ordering Code</th> </tr> </thead> <tbody> <tr> <td>Stainless steel coil housing with internal Junction Box. Internal and external ground screw.</td> <td>M 20 Connection</td> <td colspan="2">1/2" Connection</td> <td></td> </tr> <tr> <td></td> <td>No Diode</td> <td>Diode</td> <td>No Diode</td> <td>Diode</td> </tr> <tr> <td>Standard (vent to atmosphere)</td> <td>XDBS1</td> <td>XDBS5</td> <td>XDBT1</td> <td>XDBT5</td> </tr> <tr> <td>1/8" Adapter (-H2E)</td> <td>XDBS2</td> <td>XDBS6</td> <td>XDBT2</td> <td>XDBT6</td> </tr> <tr> <td>1/4" Adapter (-HE)</td> <td>XDBS3</td> <td>XDBS7</td> <td>XDBT3</td> <td>XDBT7</td> </tr> <tr> <td>Dust Nut (-L14)</td> <td>XDBS4</td> <td>XDBS8</td> <td>XDBT4</td> <td>XDBT8</td> </tr> <tr> <td>Dust Excluder (-D14)</td> <td>XDBS9</td> <td>XDBS10</td> <td>XDBT9</td> <td>XDBT10</td> </tr> </tbody> </table>		Suffix Detail Ordering Code		Stainless steel coil housing	XV	XT		1.8 watt		Standard (vent to atmosphere)	-XV1	-XT1	1/8" Adapter (-H2E)	-XV2	-XT2	1/4" Adapter (-HE)	-XV3	-XT3	Dust Nut (-L14)	-XV4	-XT4	Water proof nut (-D14)	-XV9	-XT9		Suffix Detail Ordering Code				Stainless steel coil housing with internal Junction Box. Internal and external ground screw.	M 20 Connection	1/2" Connection				No Diode	Diode	No Diode	Diode	Standard (vent to atmosphere)	XDBS1	XDBS5	XDBT1	XDBT5	1/8" Adapter (-H2E)	XDBS2	XDBS6	XDBT2	XDBT6	1/4" Adapter (-HE)	XDBS3	XDBS7	XDBT3	XDBT7	Dust Nut (-L14)	XDBS4	XDBS8	XDBT4	XDBT8	Dust Excluder (-D14)	XDBS9	XDBS10	XDBT9	XDBT10
	Suffix Detail Ordering Code																																																																		
Stainless steel coil housing	XV	XT																																																																	
	1.8 watt																																																																		
Standard (vent to atmosphere)	-XV1	-XT1																																																																	
1/8" Adapter (-H2E)	-XV2	-XT2																																																																	
1/4" Adapter (-HE)	-XV3	-XT3																																																																	
Dust Nut (-L14)	-XV4	-XT4																																																																	
Water proof nut (-D14)	-XV9	-XT9																																																																	
	Suffix Detail Ordering Code																																																																		
Stainless steel coil housing with internal Junction Box. Internal and external ground screw.	M 20 Connection	1/2" Connection																																																																	
	No Diode	Diode	No Diode	Diode																																																															
Standard (vent to atmosphere)	XDBS1	XDBS5	XDBT1	XDBT5																																																															
1/8" Adapter (-H2E)	XDBS2	XDBS6	XDBT2	XDBT6																																																															
1/4" Adapter (-HE)	XDBS3	XDBS7	XDBT3	XDBT7																																																															
Dust Nut (-L14)	XDBS4	XDBS8	XDBT4	XDBT8																																																															
Dust Excluder (-D14)	XDBS9	XDBS10	XDBT9	XDBT10																																																															

	24VDC (4W) (Consult factory for other voltage options)	Continuous duty coil & rectifier, including surge suppression, potted within housing.	Thick wall epoxy coil housing with integral junction box. Internal ground terminal. M20 x 1.5 conduit entry: (-XMAA), (-XMF), 1/2 NPT conduit entry with adapter: (-XMAF), (-XMFF)
	24VDC 10W inrush, 2.6W holding) (Consult factory for other voltages)	Continuous duty coil & power controller potted within housing.	
	24VDC (0.8W) (Consult factory for other voltages)	Continuous duty coil and power controller potted within housing.	Requires the use of an approved safety barrier or isolator. Thick wall epoxy coil housing and integral junction box. Internal ground terminal. M20 x 1.5 conduit entry: (-XIFA) 1/2 NPT conduit entry with adapter: (-XIFF)
	24VDC (1.6 watt max.) System voltage prior to barrier	Class F epoxy molded coil (155°C). Continuous duty.	Requires the use of an approved barrier or isolator. Maximum operating system voltage before barrier 28VDC. Maximum pilot pressure 115 psi (8 bar). 3 spade terminals, ISO DIN 43650, Form "A" PG9 cable gland (-HC) 1/2 NPT conduit entry: (-HCC)

HOW TO SELECT A VERSA VALVE

Every letter and digit in the product number of a has significant meaning. The product number shown below (VSG-4522-U-14-A120) indicates the following:

V	S	G	-	4	5	2	2	-	U	-	14	-	A120
PNEUMATIC SERVICE	SPRING RETURN	SOLENOID PILOT-ACTUATED		FOUR-WAY	1/2" NPT	SIDE PORTS (INPILOT)	TWO POSITION		UPRIGHT STYLE SOLENOID		SOLENOID EXHAUST/DUST EXCLUDER NUT		120V60 COIL

BASIC PRODUCT NUMBER

V	S	G	-	4	5	ACTUATING DEVICES		FUNCTIONAL TYPE OF VALVE	VALVE PORT SIZE
						ON LEFT END OF VALVE LOOKING AT INLET	ON RIGHT END OF VALVE LOOKING AT INLET		
V Series "V" Valve Pneumatic service to 200 psi (14 bar)									
T Series "T" Valve Hydraulic service to 500 psi (35 bar)									
	A	Special actuator of any type. Letter indicates position of actuator relative to right and left end of body. Suffix detail is required to designate specific actuator						2 Two-Way	2 1/8" NPT
	B	Spring Centering (for 3 position manually operated valves)						3 Three-Way	* 3 1/4" NPT
	C	Cam						4 Four-Way	4 3/8" NPT
	D	Spring Centering from one offset position only (for 3 position manually operated valves). Spring pulls spool to center						5 Five-Way (Dual Pressure Four-Way)	* 5 1/2" NPT
	E	Spring Centering from one offset position only (for 3 position manually operated valves). Spring pushes spool to center							6 3/4" NPT
	F	Pedal (for toe operation)							* 7 1" NPT
	G	Solenoid-Pilot/2 position						7 Two-Outlet (Directional Three-Way-Diverter)	7 with suffix-12 provides 1/4" (32mm) capacity with 1"NPT sideports or 1/4" NPT subplate ports
	H	Hand Lever (offset lever)							
	I	Palm Button						8 Two-Inlet (Directional Three-Way-Selector)	
	J	Pilot-Spring Centering (for 3 position pilot operated valves)							
	K	Differential Pilot Return							
	L	Hand Lever (centerline lever)							
	N	Non-return Device (for manually operated valves — allows valve to be positioned anywhere without detents)							
	P	Pressure Pilot/2 position (for bleed pilot also use suffix detail "-1")							
	R	Reverse Spring Return (for manually operated valves). Spring pulls valve spool							
	S	Spring Return. Spring pushes valve spool							
	T	Treadle (for heel-toe operation)							
	U	Three-Detent (for manually operated valves)							
	W	Diaphragm-Pilot/2 position							
	X	Solenoid-Pilot Spring Centering (for 3 position solenoid operated valves)							
	Y	Diaphragm-Pilot Spring Centering (for 3 position diaphragm operated valves)							
	Z	Two-Detent (for manually operated valves)							

For sizes 1/8" TO 1/2":
ISO 228/1 "G" type threads are indicated by additional use of suffix "-2B". Contact factory for availability.

*Basic valve size

SELECTOR CHART

SUFFIX DETAILS

Suffix details indicate modifications or variations to the basic valve. When specifying simply add those suffix details required in alphanumeric order.

Listed below are the suffix detail modifications found in this catalog and the page on which they are noted.

2

2

-U-14-

COIL CODE

BODY DETAILS

SPOOL DETAILS (Flow patterns)

OPTIONS/VOLTAGES SUFFIX DETAILS

0 SIDEPORTED-EXPILOT

Body with integral, pipe threaded ports. This type of body is directly connected to pressure lines and is used for mechanical, manual and EXPilot* type solenoid or pilot actuated valves.

1 SUBPLATE MOUNTING-EXPILOT

Body-ported for subplate mounting. This type of body is screw connected to a subplate or manifold that is connected to pressure lines and is used for mechanical, manual and EXPilot* type solenoid or pilot actuated valves.

2 SIDEPORTED - INPILOT

Body same as "0" above, except it has an auxiliary internal passage to supply INPilot** type solenoid and pilot actuators.

3 SUBPLATE MOUNTING-INPILOT

Body same as "1" above, except it has internal auxiliary passage to supply INPilot** type solenoid and pilot actuators.

*Separate pressure line connection needed to supply solenoid-pilot, differential pilot return or to control pressure pilot.

**Internal auxiliary porting supplies pressurized medium being controlled to pilot, solenoid- pilot or differential pilot return.

TWO-WAY or THREE-WAY VALVES Two Position

- 1 Normally Closed (actuating device must be on right end of valve)
- 2 Normally Open (actuating device must be on left end of valve)

THREE-WAY VALVES Three Position

- 3 All ports blocked in center position

FOUR-WAY VALVES Two Position

- 2 Standard flow pattern: inlet alternately open to one cylinder port; opposite cylinder port alternately open to exhaust.

FIVE-WAY VALVES Two Position

- 2 Standard flow pattern: each inlet port open (alternately) to one cylinder port; opposite cylinder port open (alternately) to exhaust

FOUR-WAY OR FIVE-WAY VALVES Three Position

- (Offset flows as standard flow patterns, above)
- Center Position**
- 3 All ports blocked
 - 4 Cylinder ports open to exhaust
 - 8 Inlet(s) open to both cylinder ports
 - 9 All ports open

DIVERTER & SELECTOR VALVES

- 2 2-position
- 3 All ports blocked in center position

Actuator Orientation:

- 218A thru -218G, Hand Lever, page 14
- 226, Cam actuator, page 15
- 227A thru -227C, Pilot actuator, page 15

Combination Actuators:

- 33, Retainer cap, page 59
- 113, -113L, Hand/2-detent, page 62 & 63
- 114, -114L, Hand/3-detent, page 62 & 63
- 115, Palm button/2-detent, page 62
- 130A, -130L Hand/spring return, page 62 & 63
- 136, Palm button/spring return, page 62
- 138, Solenoid/spring return, page 64
- 150, Pilot/2-detent, page 63
- 159, Pilot/spring return, page 64
- 173, Solenoid/detent, page 64
- 181D, Latching Resets page 68

Solenoid Options:

For General Purpose:

- 243, Grommeted housing, page 9
- HC, -HCC, DIN connector, page 9 - 11
- HT, Class H coil, Page 9 - 11
- P, Plug-in coil
- PC, -PS, Potted coil (Ingress Protection NEMA 4/4X)

Popular Option Combo's for Hazardous Service (see page 9-11)

- XXE4 Hazardous weather protected, UL/CSA (-XX, -D14, -PC, -ST)
- XXL4, Hazardous, weather protected, UL/CSA (-XX, -D14, -PC)
- XXN4 Hazardous, weather protected, UL/CSA (-XX, -D14, -LB, -PC)
- XNE4 Hazardous, weather protected, ATEX (-XN, D14, -PC, -ST)
- XNJ,4 Hazardous, weather protected, ATEX (-XN, -D14, -LB, -PC, -ST)
- XDBS9 (d)Flameproof, World Solenoid (-XDBS, -HT, -LX, -D14)
- XDBT9 (d)Flameproof, World Solenoid (-XDTS, -HT, -LX, -D14)
- XV9 weather protected, UL/CSA (-XV, -HT, -LX, -D14)
- XT9 (d)Flameproof, World Solenoid, ATEX (-XT, -HT, -LX, -D14)

For Hazardous Service WITH INTEGRAL Junction Box (Page 9 - 11):

- XDBS, -XDBT, (d)Flameproof, ATEX, IEC, CSA, INMETRO
- XIFA, -XIFE, -XIFF, (ib)Intrinsic Safe, ATEX
- XMAA, -XMAE, -XMAF, (m)Encapsulation, (e)Increased Safety, ATEX
- XMFA, -XMFE, -XMFF, (m)Encapsulation, (e)Increased Safety, ATEX

For Hazardous Service (Page 9 - 11):

- XX, Hazardous locations, UL & CSA
- XN, (d)Flameproof, ATEX
- XV, Hazardous locations; World Solenoid
- XT, Hazardous locations; World Solenoid

For Intrinsic Safe (see page 10)

- XISC, -XISX6 (ib)Intrinsic Safe, ATEX FM & CSA
- HC, -HCC, Connector for IS

Manual Override (page 17):

- G, Guarded
- G5R, Guarded-locking
- M, Unguarded
- M5R, Unguarded-locking

Seals:

- 3, Continuous duty solenoid/high temp core, fluorocarbon FKM, page 9
- 11, High nitrile NBR, page 4, 7 & 9
- 31, U-cup pilot, page 6
- 155, Fluorocarbon FKM, page 4, 7 & 9
- EP, Ethylene propylene EPR, page 4

Special service/lubrication:

- 1, Bleed pilot, page 14 & 19
- 10, Electroless nickel plating-internal, page 4
- 14, Silencer/dustproof coil cover nut
- 21, INPilot/EXPilot
- 55A, FDA approved silicone grease, page 7
- 55M, Silicone grease, page 7
- 167, Electroless nickel plating-external, page 4
- 200, Plus pressure rating to 200 psi (14 bar), page 6
- H, Threaded solenoid exhaust, page 17
- H500, Hydraulic solenoid rated to 450 psi (31 bar), page 6
- NGS, -NGST Natural Gas Service - Low Temperature

Tagging:

- NV28A, Stainless steel ID tag; see page 71

Solenoid actuated valves require a Coil Code that indicates the specific coil current/frequency and voltage. The Coil Code consists of a letter to indicate the current frequency:

Rating Code:

- A= 60Hz frequency
- D= Direct Current (DC)
- E= 50Hz frequency

Three numbers follow the Rating Code to indicate voltage:

Examples:

Code	Voltage
24V60 =	024
120V60 =	120
24VDC =	024

See Page 9 for specific coil and codes.

ACTUATING DEVICES

Versa has available over thirty standard devices to actuate Series V or Series T valves. The basic purpose of the actuating device is to provide a means of shifting the valve spool back and forth in order that it may perform the various valving functions necessary. Because of the balanced design and action of the valve spool, the force required to shift this spool is separate and unaffected by the pressure being controlled by the valve.

The actuators are designed for application within 3 ranges of valve sizes: one range of actuators for all valve styles, types, and sizes $\frac{1}{8}$ " through $\frac{1}{2}$ "; another range of actuators for sizes $\frac{3}{4}$ " through 1"; and one range of actuators for $1\frac{1}{4}$ " valves. Within their broad respective ranges, Versa actuators are completely interchangeable on all body styles, types, and sizes. Except for valves that are specifically normally closed or normally open, these actuators may even be shifted from end-to-end on the valve body to suit any specific piping layout or space requirement.

Illustrated with brief descriptions, are the basic types of actuators in most frequent use. The "letters" referred to by the actuator types coincide with the prefix letters used in the product numbering system. Many variations and modifications of these basic actuators are also available. A few are described on Page 13 under Suffix Details. Others, such as combination actuators, can be found on Pages 62 thru 64.

PARTS INFORMATION – the number inside the box refers to the page number for parts information. Dimensioning information is found in each of the specific valve sections.



MANUAL

A push or pull motion may be used to operate the hand device in order to shift the valve spool. If used with a detent device ("U" or "Z") or a no-spring device ("N") the handle must be actuated and returned manually. With a spring centering device ("B") the handle will normally be in the center position when not actuated, or will return to the center position after being actuated. To actuate with a spring centering device, the handle must be pulled to one offset position and pushed to the other. The precise differences of each of the three hand actuating devices are described below.

TYPE "H" HAND LEVER (Offset Mounted)

The handle of this device is offset from the valve, and may be located on either side of the valve. Standard assembly places the handle on the side having the outlet ports. The entire hand actuating device may be rotated into positions at increments of 90° from vertical. (For various options available see below.) When mounted so that handle works in a vertical plane a back and forth motion is provided. When mounted so that the handle works in a horizontal plane a rotary motion is provided.

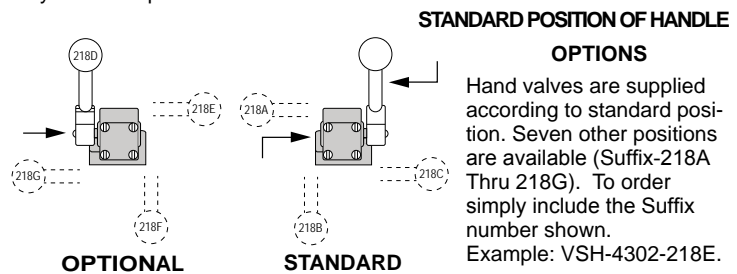

TYPE "L" HAND LEVER (Centerline Mounted)

The handle of this device is in the vertical plane through the centerline of the valve body and is required when dustproof feature is desired. On models up to 1/2" pipe size, a rubber boot provides protection from dirt and dust. The entire device may be rotated into positions at increments of 90° from vertical. To indicate, use Suffix -218A, -218B, or -218C as shown above for offset mounted hand lever.

TYPE "I" PALM BUTTON (Panel Mounting Is Standard)

The body of the Palm Button actuator is supplied with a thread and nut that allows the actuator, when required, to be fastened to a panel with the valve behind the panel. The button will then project through and be visible from the front panel. Pushing or pulling the button activates the valve.

FOOT

TYPE "F" PEDAL

Applied to 2-position valves only and is usually used with either a spring return ("S") or differential pilot return ("K") device. The pedal lends itself to tiptoe operation. Actuation is accomplished when operator depresses pedal. When operator removes foot from pedal, pedal is returned or reset to un-actuated position by return device on other end of valve.

Foot Guard

Heavy all-steel construction protects the valve mechanism from abuse. Acts as a sturdy base for valves that cannot be secured to floor or equipment, or may be bolted down for permanent installation. One size Foot Guard fits all sizes and types of pedal* actuated Versa Valves.

* Any Versa valve with the prefix product letter "F," i.e. VSF-3301.
Not suitable for treadle operation

TYPE "T" TREADLE

Provides full support for the foot of the operator. This device may be used with 2-position or 3-position valves. When used in conjunction with a spring return ("S") or a differential pilot return ("K"), actuation is provided by the operator depressing the treadle with his heel. When used with a reverse spring device ("R"), actuation is provided when operator depresses the treadle with his toe. With a detent device ("U" or "Z"), a no-spring return device ("N"), or a spring centering device ("B") actuation is provided by depressing with the heel to one offset position and by depressing with the toe to the other offset position.

MECHANICAL

The cam roller may be actuated by a cam, trip bar or a straight line push from some machine member. Standard assembly provides the roller revolving in a horizontal plane, but entire device may be rotated so that cam roller acts in a plane perpendicular to mounting surface (see arrangement options below)

TYPE "C" CAM ACTUATOR (Normal Duty)

Utilizes case hardened roller. Recommended maximum pressure angle 15°.

TYPE "C" +suffix "-18S" (Heavy Duty) CAM ACTUATOR

Roller is a double shielded ball bearing. Provides overtravel of 1/4" for easier mounting and valve protection. Recommended maximum pressure angle 15°.

OPTIONS For Both Types

Cam valves are supplied with roller axis perpendicular to the mounting surface. Should you require the axis parallel to the mounting surface (shown at right) simply include suffix number shown.
Example: VSC-4302-226.

STANDARD
ROLLER AXIS
PERPENDICULAR

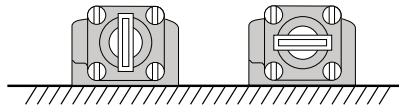

OPTIONAL
(SUFFIX -226)
ROLLER AXIS
PARALLEL

PILOT

The pilot actuator is a small cylinder and piston that is an integral part of the valve and which, when pressurized or unpressurized, actuates the valve.

TYPE "P" PRESSURE PILOT (for 2-position valves)

60

TYPE "J" PRESSURE PILOT (for 3-position valves)

61

This pilot requires pressure to actuate the valve, and release of the pressure to return the valve. Usually it is controlled by a small Three-Way valve. The pilot port on the 1/8" through 1/2" valves may be rotated to any position in 90° increments from vertical. (See option arrangements below).

When used in pairs for 2-position valves, it is not necessary to maintain pressure on the actuated pilot in order for the valve to remain in actuated position. Valve will remain in last position until signalled by the opposite pilot to return. When used with spring centering feature ("J"), valve will remain in center position until actuated by either pilot. To remain in actuated position, pilot must remain pressurized until it is required for valve to return to center position.

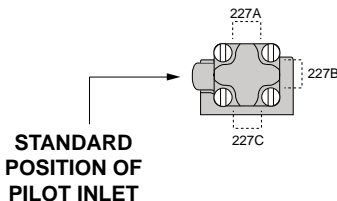

OPTIONS

Pilot actuated valves (1/8" thru 1/2") are supplied with the pilot port facing the same direction as the inlet port of the valve proper. Three other positions are available (Suffix-227A thru -227C). To order simply include the suffix number shown.
Example: VSP-4302-227A.



PEDAL

Part Number

FG - 1R (when pedal is on the right.)

FG - 1L (when pedal is on the left).



Foot Guard



TREADLE



CAM ACTUATOR
(Normal Duty)



CAM ACTUATOR
(Heavy Duty)



PILOT

60

61

ACTUATING DEVICES

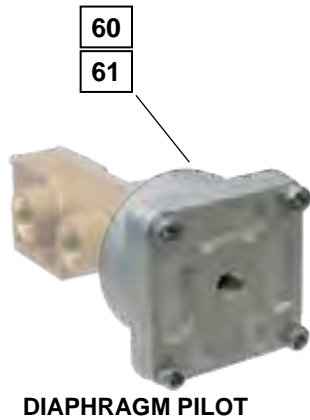

DIAPHRAGM PILOT

TYPE "P" (+suffix "-1") BLEED PILOT 60

The bleed type pilot is constantly supplied with pressure from the inlet of the valve and requires valve body for INPilot operation. In order to actuate the bleed type pilot, it is necessary to discharge pressure from the pilot causing a pressure drop sufficient for the return device to operate. Usually the bleed type pilot is used in pairs and is operated by Two-Way valves

TYPE "W" DIAPHRAGM PILOT (for 2-position valves) 60

TYPE "Y" DIAPHRAGM PILOT (for 3-position valves) 61

A large pilot area allows the diaphragm pilot to function on very low signal pressures. Usually controlled by a Three-Way valve, the diaphragm pilot requires pressure to actuate. When used in pairs for 2-position valves, it is not necessary to maintain pressure on actuated pilot in order for valve to remain in actuated position. Valve will remain in last position until signalled by opposite pilot to return. When used with spring centering feature ("Y") valve will remain in center position until actuated by pilot. To remain in actuated position, pilot must remain pressurized until it is required for valve to return to center position.

SOLENOID/PILOT

A low power solenoid controls a built-in pilot which provides the positive force for shifting the valve spool. When used with a spring return ("S") or differential pilot return ("K") the valve will be actuated when the solenoid is energized and will return when the solenoid is de-energized. When used in pairs for 2-position valves, the solenoid need only be energized momentarily in order to shift the valve. The valve will then remain in the shifted position until signalled to return by the opposite solenoid. In spring centering models ("X") the valve will remain in the center position until one of the solenoids is energized. It is necessary to maintain energy on the solenoid as long as it is desired for the valve to remain in the shifted position. When de-energized, the valve will return to the center position.

STANDARD COILS are epoxy molded. For AC and DC voltages available, see Page 9 - 11.

Two Piloting devices are available depending upon the service to which they will be applied

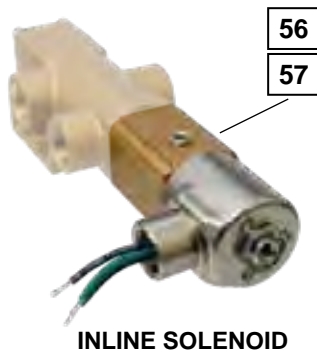

INLINE SOLENOID

INPilot- utilizes the pressure from the inlet of the valve, through internal passages, to the solenoid-pilot. In this type valve, only one pressure connection, the inlet, is necessary.

EXPilot- requires a separate auxiliary pressure line to the solenoid-pilot. Should be used when valve is controlling vacuum, when pressure will be below the minimum recommended for INPilot operation or when viscosity of controlled medium is such that it will impede the speed of actuation. In any case, the pressure source may be either air or liquid and is independent of the medium which is being controlled by the valve.

TYPE "G" INLINE SOLENOID/PILOT (for 2-position valves) 56

TYPE "X" INLINE SOLENOID/PILOT (for 3-position valves) 57

Coils of actuator are placed on end of valve in line with the longitudinal axis through the valve. Allows valve to be tucked away into relatively narrow spaces.



UPRIGHT SOLENOID PILOT

TYPE "G" (+suffix "-U") UPRIGHT SOLENOID/PILOT (for 2-position valves) 56

TYPE "X" (+suffix "-U") UPRIGHT SOLENOID/PILOT (for 3-position valves) 57

Coils of actuator are placed on top of solenoid cap so as to be perpendicular to the longitudinal axis of the valve. Shortens overall length of valve. Used as standard for valves equipped with hazardous location solenoids (suffix "-XX") or plug-in solenoids, (suffix "-P").

SOME OPTIONS AVAILABLE

- Hazardous Service solenoid:
- Low Watt Hazardous Service Solenoid:
- DIN Coil & Connector: (Suffix -HC, -HCC, -HCCL, -HCL)
- Coil potted within housing; NEMA 4/4X Rating: (Suffix -PC)
- Continuous Duty Solenoid: (Suffix -3)
See Pages 9 - 11 for information on above

Shown:

- Manual Override: (Suffix -G, -G5R, -M, -M5R)
- Threaded Solenoid Exhaust Adapter: (Suffix -H -H2)
- Dust excluders for solenoid exhaust:
Dust Proof: (Suffix -L14)
Water Tight: (Suffix -D14)

MANUAL OVERRIDES



Exhaust Adapter



Excluders



SPRING RETURN 61

A device for returning the valve spool to its original position in 2-position valves.

TYPE "S"

Can be used on any type valve. Pushes valve Spool.

TYPE "R"

For use with Hand or Treadle Operated valves usually. Pulls valve spool.

NO-SPRING RETURN 61

TYPE "N"

For use on Hand or Treadle Operated valves only. Used when automatic return of valve spool is not desired. Spool will stay in last position placed until operated to another position

DETENT 60

A device that establishes a definite "feel" indicating when valve is in a specific position. Also prevents spool from shifting should excessive vibration be present. Generally used with Hand or Treadle Operated valves, but can also be supplied, in some cases, for Pilot and Solenoid/Pilot Operated valves as a Combination Actuator.

TYPE "U"

3-position detent for 3-position valves. Provides detent in each offset position and center position as well.

TYPE "Z"

2-position detent for 2-position valves. Provides detent in both offset positions.

DIFFERENTIAL PILOT RETURN

TYPE "K"

Utilizes air or oil pressure in place of spring return in order to shift valve spool. Can be used in any 2-position valve.

- INPilot type uses pressure from inlet of valve; no auxiliary piping required.
- EXPilot type requires auxiliary source of pressure. Used when pressure being controlled by the valve is not sufficient to shift valve spool.

SPRING CENTERING DEVICE

A device for returning the valve spool to center position in Hand and Treadle Operated valves only. Spring centering devices for Pilot or Solenoid/Pilot Operated valves are an integral part of the specific actuator.

TYPE "B" spring centers from both offset positions.

TYPE "D" spring centers from only one offset position; pulls spool to center

TYPE "E" spring centers from only one offset position; pushes spool to center.



SPRING RETURN, NO
SPRING RETURNDETENT



DIFFERENTIAL
PILOT RETURN



SPRING CENTERING

2 WAY VALVES 2/2

Two-Way Valves are on-off valves. They are supplied with an inlet and an outlet port that is either normally closed or normally open to the inlet in the unactuated position. Two-Way Valves are usually used to open or close a pressure line such as in applications involving spraying, air ejection, clearing chips, powering an air motor or operating the pilot of bleed-pilot valves.

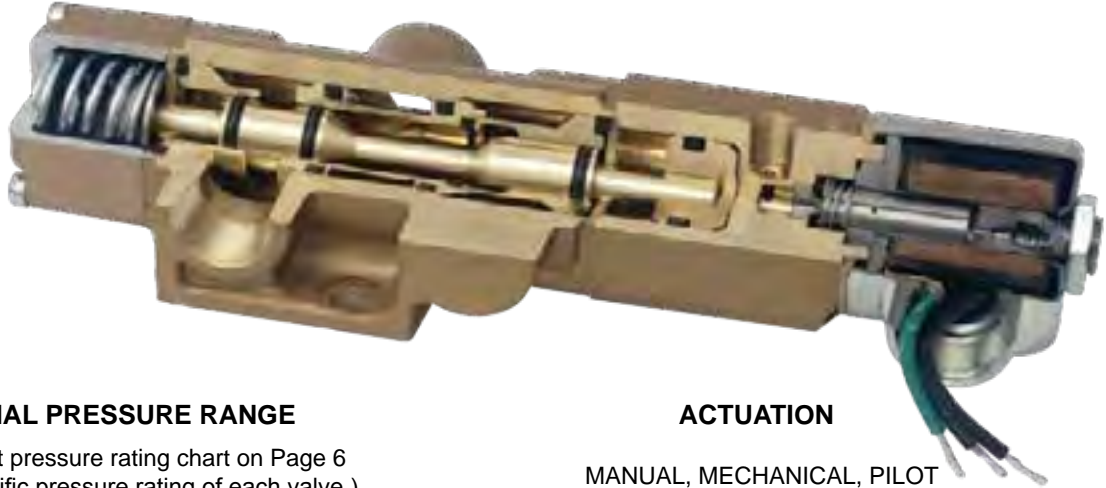

NOMINAL PRESSURE RANGE

(Consult pressure rating chart on Page 6 for specific pressure rating of each valve.)

Series "V": partial vacuum to 200 psi (14 bar) pneumatic

Series "T": 0-500 psi (35 bar) hydraulic

ACTUATION

MANUAL, MECHANICAL, PILOT
or SOLENOID-PILOT

BODY TYPES:

All Series "V" & "T" Two-Way Valves are available in the two body types described below. Actuators used with either body type are completely interchangeable.

SIDE-PORTED

The side-ported body provides threaded ports in the body of the valve.



PORT SIZES: 1/8, 1/4, 3/8, 1/2, 3/4, and 1 NPT
1/8, 1/4, 3/8, and 1/2 G

SUB-PLATE MOUNTING

The Sub-plate mounting valve is shown mounted on an individual sub-plate. See page 24 for details on the sub-plate.



PORT SIZES: 1/8, 1/4, 3/8, 1/2, 3/4, 1, 1-1/4 NPT and G

SPECIFICATIONS

Refer to pages 3 through 11 for information concerning:

- Construction
- Seals
- Port Sizes
- Flow
- Pressure Ranges
- Electrical
- Temperature
- Filtration & Lubrication

STANDARD FLOW PATTERNS

ONE INLET, ONE OUTLET 2/2

Valves must be connected in accordance with the port markings so that the flow is from the inlet port to the outlet port. The flow within the valve should never be reversed.

Note: When used in a vacuum system, the vacuum pump is connected to the outlet port.

TWO POSITION

1. VALVE NORMALLY CLOSED (actuator mounted on right end of valve)

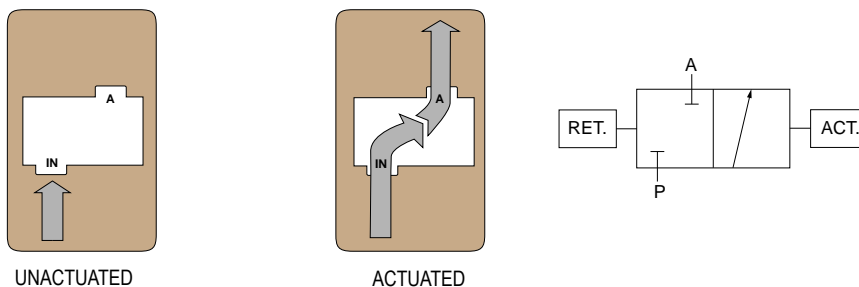

2. VALVE NORMALLY OPEN (actuator mounted on left end of valve)

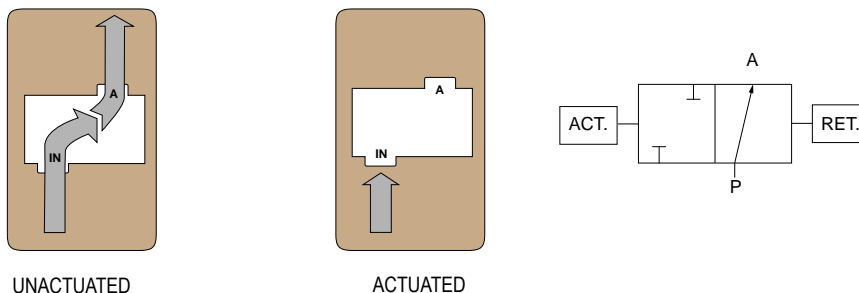

2

WAY-MOUNTING DIMENSIONS

Port hole locations and mounting hole size and locations shown in the individual Body Detail below apply to all Two-Way valves, regardless of type of actuation. The overall dimensions shown for each type of valve actuation apply whether for side ported or sub-plate mounting type.

BODY DETAIL

SIDEPORTED

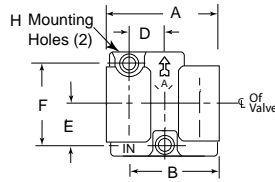

SUBPLATE MOUNTING

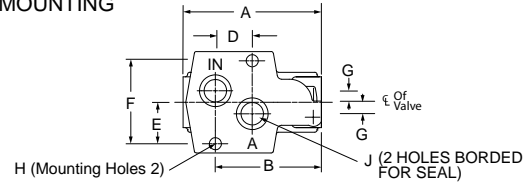

SIZE	A		B		D		E		F		G		H Ø		J Ø	
	in	mm	in	mm	in	mm	in	mm	in	mm	in	mm	in	mm	in	mm
1/8-1/4 SIDE PORTED or SUB-PLATE MOUNTING	2.19	56	1.75	45	0.66	17	0.8	20	1.59	40	0.19	5	0.256	6.5	0.38	9.7
3/8-1/2 SIDE PORTED or SUB-PLATE MOUNTING	3.75	95	2.88	73	1	25	1.13	29	2.25	57	0.31	7.9	0.33	8	0.56	14
3/4-1 SIDE PORTED or SUB-PLATE MOUNTING	5.5	140	4.25	108	1.5	38	1.56	40	3.13	79	0.44	11.2	0.39	10	1	25
1-1/4" SIDE PORTED or SUB-PLATE MOUNTING	5.5	140	4.25	108	1.5	38	1.56	40	3.13	79	0.44	11.2	0.39	10	1.25	32

HAND ACTUATED VALVES

OFFSET LEVER TYPE

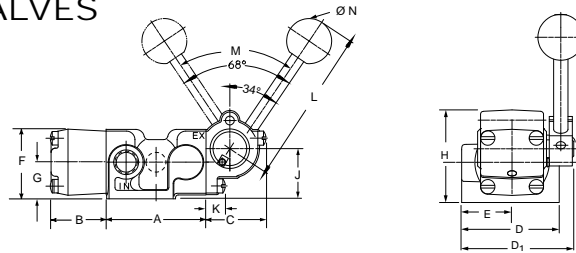

SIZE	A		B		C		D1		D		E		F		G		H		J		K		L		M	N Ø	
	in	mm	in	mm	in	mm	in	mm	in	mm	in	mm	in	mm	in	mm	in	mm	in	mm	in	mm	in	mm	°	in	mm
1/8-1/4	2.19	56	1.22	31	1.34	34	2.31	59	2	51	1	25	1.5	38	0.81	21	2	51	1.13	29	0.53	13	3	76	68	1	25
3/8-1/2	3.75	95	1.22	31	1.34	34	2.75	70	2.75	70	1.38	35	1.69	43	0.88	22	2.06	52	1.19	30	0.53	13	3	76	68	1	25
3/4-1	5.5	140	2.06	52	2	51	3.75	95	3.75	95	1.88	48	2.44	62	1.25	32	2.97	75	1.72	44	0.81	21	5	127	62	1.25	32

CENTERLINE LEVER TYPE

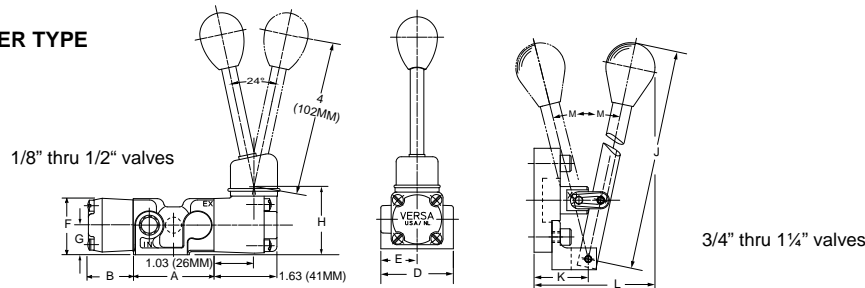

SIZE	A		B		D		E		F		G		H		J		K		L		M	
	in	mm	in	mm	in	mm	in	mm	in	mm	in	mm	in	mm	in	mm	in	mm	in	mm	°	
1/8-1/4	2.19	56	1.22	31	2	51	1	25	1.5	38	0.81	21	1.81	46	—	—	—	—	—	—	—	—
3/8-1/2	3.75	95	1.22	31	2.75	70	1.38	35	1.69	43	0.88	22	1.88	48	—	—	—	—	—	—	—	—
3/4-1	5.5	140	2.06	52	3.75	95	1.88	48	2.44	62	1.25	32	—	—	8	203	1.31	33	3.75	95	13	
1-1/4†	5.5	140	2.06	52	3.75	95	1.88	48	2.44	62	1.25	32	—	—	8.88	225	2.31	59	5.69	145	18.5	

†1 1/4" size valve has internal capacity of 1 1/4" (32mm) diameter. Sideported valves have 1" NPT ports; subplate for subplate mounting style has 1 1/4" NPT ports.

BUTTON ACTUATED VALVES

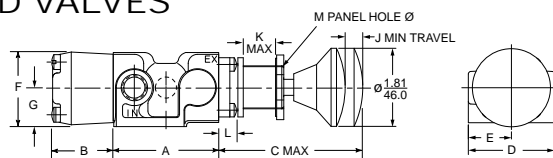

SIZE	A		B		C		D		E		F		G		J		K		L		M	
	in	mm	in	mm	in	mm	in	mm	in	mm	in	mm	in	mm	in	mm	in	mm	in	mm	in	mm
1/8-1/4	2.19	56	1.22	31	3.25	83	2	51	1	25	1.5	38	0.81	21	0.38	9.7	0.75	19	0.53	13	1	25
3/8-1/2	3.75	95	1.22	31	3.25	83	2.75	70	1.38	35	1.69	43	0.88	22	0.38	9.7	0.75	19	0.53	13	1	25
3/4-1	5.5	140	2.06	52	4.34	110	3.75	95	1.88	48	2.44	62	1.25	32	0.59	15	1.38	35	0.69	18	1.38	35

FOOT ACTUATED VALVES/PEDAL and TREADLE

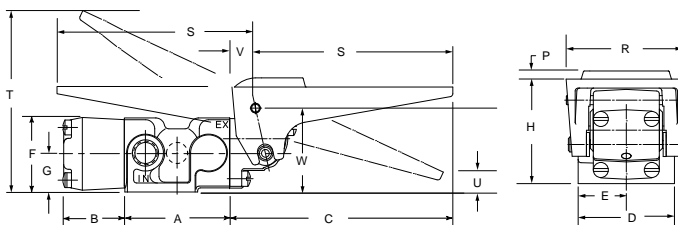

SIZE	A		B		C		D		E		F		G		H		P		R		S		T		U		V		W	
	in	mm	in	mm	in	mm	in	mm	in	mm	in	mm	in	mm	in	mm	in	mm	in	mm	in	mm	in	mm	in	mm	in	mm	in	mm
1/8-1/4	2.19	56	1.22	31	4.53	115	2	51	1	25	1.5	38	0.81	21	2.13	54	0.19	5	2.5	64	4	102	3.81	97	0.38	9.7	0.5	13	1.75	45
3/8-1/2	3.75	95	1.22	31	4.53	115	2.75	70	1.38	35	1.69	43	0.88	22	2.19	56	0.19	5	2.5	64	4	102	3.94	100	0.44	11	0.5	13	1.81	46
3/4-1	5.5	140	2.06	52	4.81	122	3.75	95	1.88	48	2.44	62	1.25	32	3.19	81	.25	6	3.63	92	4	102	5	127	1	25	0.63	16	2.69	68

CAM ACTUATED VALVES

NORMAL DUTY

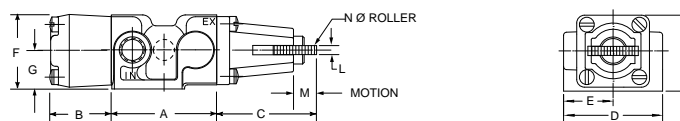

SIZE	A		B		C		D		E		F		G		L		M		N	
	in	mm	in	mm	in	mm	in	mm	in	mm	in	mm	in	mm	in	mm	in	mm	in	mm
1/8-1/4	2.19	56	1.22	31	2	51	2	51	1	25	1.5	38	0.81	21	0.19	5	0.38	9.7	0.88	22
3/8-1/2	3.75	95	1.22	31	2	51	2.75	70	1.38	35	1.69	43	0.88	22	0.19	5	0.38	9.7	0.88	22
3/4-1	5.5	140	2.06	52	3.22	82	3.75	95	1.88	48	2.44	62	1.25	32	0.31	7.9	0.63	16	1.25	32

HEAVY DUTY

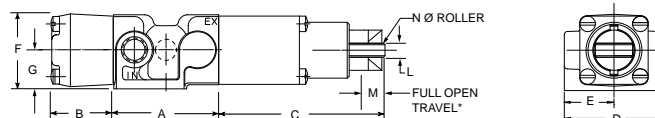

SIZE	A		B		C		D		E		F		G		L		M		N	
	in	mm	in	mm	in	mm	in	mm	in	mm	in	mm	in	mm	in	mm	in	mm	in	mm
1/8-1/4	2.19	56	1.22	31	3.34	85	2	51	1	25	1.5	38	.81	21	0.28	7	.4	10	0.75	19
3/8-1/2	3.75	95	1.22	31	3.34	85	2.75	70	1.38	35	1.69	43	0.88	22	0.28	7	.4	10	0.75	19

*Maximum Permissible Over-Travel — 1/4" (6.4mm)

Refer to page 20 under Body Detail, for port and mounting hole locations for all valves shown above.

2

WAY-MOUNTING DIMENSIONS

PILOT ACTUATED VALVES

SINGLE PILOT

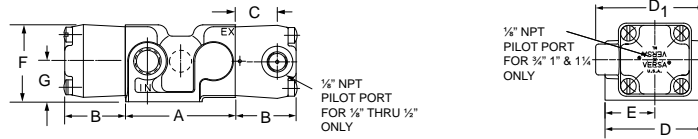

DOUBLE PILOT

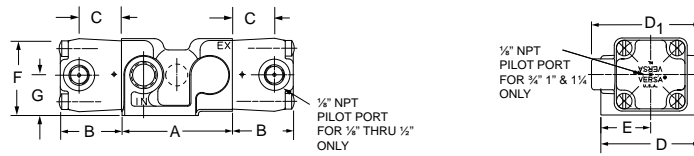

SIZE	A		B		C		D1		D		E		F		G	
	in	mm	in	mm	in	mm	in	mm	in	mm	in	mm	in	mm	in	mm
1/8-1/4	2.19	56	1.22	31	0.84	21	2.19	56	2	51	1	25	1.5	38	0.81	21
3/8-1/2	3.75	95	1.22	31	0.84	21	2.69	68	2.75	70	1.38	35	1.69	43	0.88	22
3/4-1-1/4†	5.5	140	2.06	52	—	—	—	—	3.75	95	1.88	48	2.44	62	1.25	32

DIAPHRAGM ACTUATED VALVES

SINGLE DIAPHRAGM

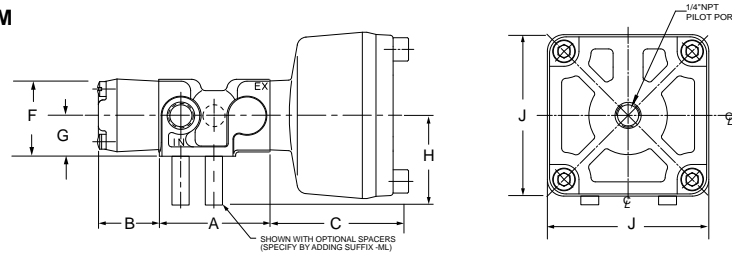

DOUBLE DIAPHRAGM

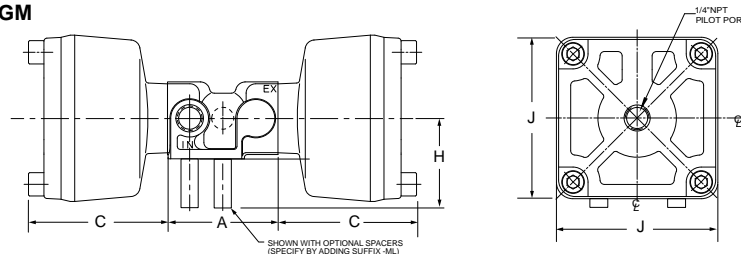

SIZE	A		B		C		F		G		H		J	
	in	mm	in	mm	in	mm	in	mm	in	mm	in	mm	in	mm
1/8-1/4	2.19	56	1.22	31	2.75	70	1.5	38	0.81	21	1.69	43	3.34	85
3/8-1/2	3.75	95	1.22	31	2.75	70	1.69	43	0.88	22	1.75	45	3.34	85
3/4-1	5.5	140	2.06	52	2.97	75	2.44	62	1.25	32	1.75	45	3.25	83
1-1/4†	5.5	140	2.06	52	3.22	82	2.44	62	1.25	32	1.75	45	3.25	83

Refer to page 20 under Body Detail, for port and mounting hole locations for all valves shown above.

†1 1/4" size valve has internal capacity of 1 1/4" (32mm) diameter. Sideported valves have 1" NPT ports; subplate for subplate mounting style has 1 1/4" NPT ports

SOLENOID ACTUATED VALVES/INLINE (Non Hazardous Service)

SINGLE SOLENOID

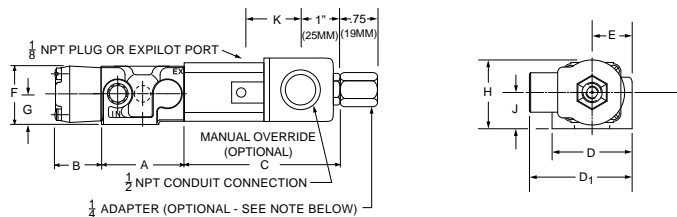

DOUBLE SOLENOID

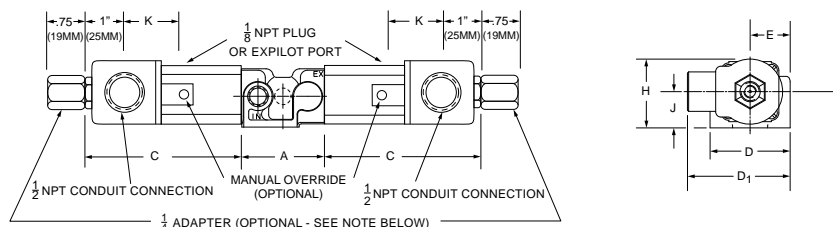

SIZE	A		B		C		D1		D		E		F		G		H		J		K	
	in	mm	in	mm	in	mm	in	mm	in	mm	in	mm	in	mm	in	mm	in	mm	in	mm	in	mm
1/8-1/4	2.19	56	1.22	31	3.94	100	2.56	65	2	51	1	25	1.5	38	0.81	21	1.72	44	0.91	23	1.63	41
3/8-1/2	3.75	95	1.22	31	3.94	100	2.94	75	2.75	70	1.38	35	1.69	43	0.88	22	1.78	45	0.97	25	1.63	41
3/4-1-1 1/4†	5.5	140	2.06	52	4.5	114	3.44	87	3.75	95	1.88	48	2.44	62	1.25	32	2	62	1.25	32	1.41	36

NOTE: Adapter is supplied when specified, by adding suffix "-H" to product number

SOLENOID ACTUATED VALVES/UPRIGHT (Non Hazardous Service . For hazardous service valves see pages 9 - 11.)

SINGLE SOLENOID

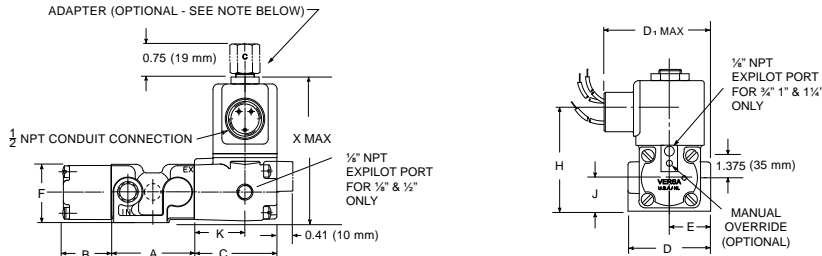

DOUBLE SOLENOID

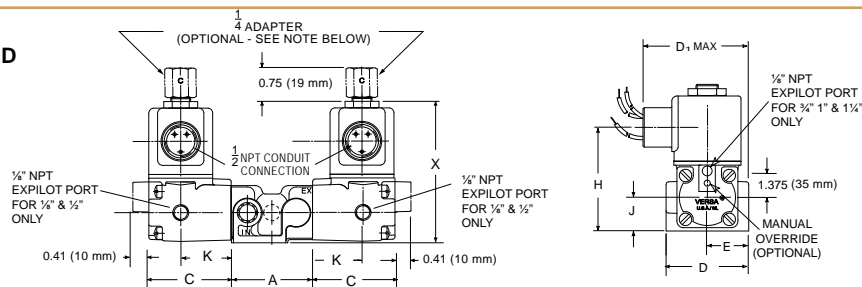

SIZE	A		B		C		D1		D		E		F		H		J		K		X	
	in	mm	in	mm	in	mm	in	mm	in	mm	in	mm	in	mm	in	mm	in	mm	in	mm	in	mm
1/8-1/4	2.19	56	1.22	31	2.09	53	2.5	64	2	51	1	25	1.5	38	2.59	66	0.81	21	1.28	33	3.81	97
3/8-1/2	3.75	95	1.22	31	2.09	53	2.88	73	2.75	70	1.38	35	1.69	43	2.66	68	0.88	22	1.28	33	3.88	99
3/4-1-1 1/4†	5.5	140	2.06	52	2	51	3.44	87	3.75	95	1.88	48	2.44	62	3.91	99	1.25	32	1	25	5.16	131

NOTE: Adapter is supplied when specified, by adding suffix "-H" to product number

Refer to page 20 under Body Detail, for port and mounting hole locations for all valves shown above.
 †1 1/4" size valve has internal capacity of 1 1/4" (32mm) diameter. Sideported valves have 1" NPT ports; subplate for subplate mounting style has 1 1/4" NPT ports.

SUB-PLATES (SINGLE STATION TYPE)

Will mount series "V" or "T" sub-plate type valves. Multiple valve station manifolds (VM Co-Ordinates) for the mounting of several valves are also available. See page 25. For sub-plates to mount plug-in solenoids, consult factory.

FOR TWO-WAY VALVES

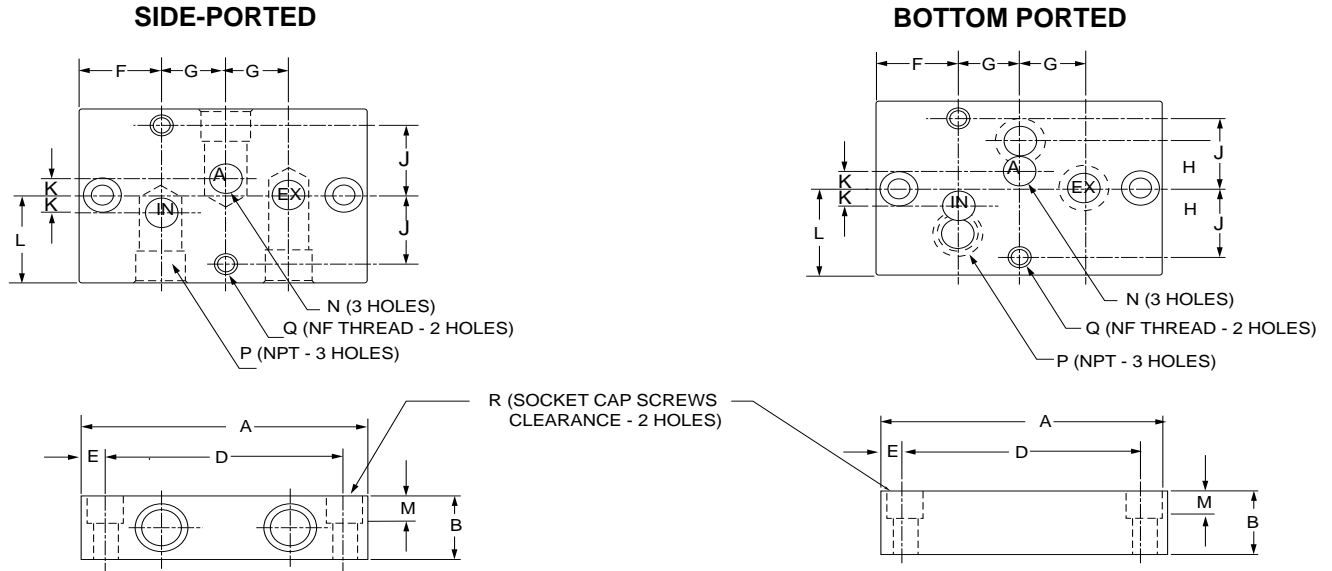

SUB-PLATE PRODUCT NUMBERS *Product numbers shown provide NPT ports. For ports with G thread add Suffix-2B.	Side Ported	M-320-A	M-330-A	M-340-A	M-350-A	M-360-A	M-370-A	M-370-A-12	—							
	Bottom Ported	M-321-A	M-331-A	M-341-A	M-351-A	M-361-A	M-371-A	—	M-371-A-12							
VALVE SIZE	1/8		1/4		3/8		1/2		3/4		1		1 1/4		1 1/4	
	in	mm	in	mm	in	mm	in	mm	in	mm	in	mm	in	mm	in	mm
A	3	76	3	76	4	102	4	102	6.125	156	6.125	156	6.125	156	6.125	156
B	0.75	19	0.75	19	1.25	32	1.25	32	2	51	2	51	2.5	64	2	51
C	2	51	2	51	3	76	3	76	4	102	4	102	4	102	4	102
D	2.5	64	2.5	64	3.38	86	3.38	86	5.25	133	5.25	133	See note below			
E	0.25	6	0.25	6	0.31	7.9	0.31	7.9	0.44	11	0.44	11	0.44	11	0.44	11
F	0.84	21	0.84	21	1	25	1	25	1.56	40	1.56	40	1.56	40	1.56	40
G	0.66	17	0.66	17	1	25	1	25	1.5	38	1.5	38	1.5	38	1.5	38
H	0.375	10	0.375	10	0.625	16	0.625	16	1	25	1	25	1.25	32	—	—
J	0.78	20	0.78	20	1.125	29	1.125	29	1.56	40	1.56	40	See note below			
K	0.19	5	0.19	5	0.31	7.9	0.31	7.9	0.44	11	0.44	11	0.44	11	0.44	11
L	1	25	1	25	1.5	38	1.5	38	2	51	2	51	2	51	2	51
M	0.5	13	0.5	13	0.75	19	0.75	19	1	25	1	25	—	—	1	25
N	0.375	10	0.375	10	.625	16	.625	16	1	25	1	25	1.25	32	1.25	32
* P	1/8 NPT		1/4 NPT		3/8 NPT		1/2 NPT		3/4 NPT		1 NPT		1 1/4 NPT		1 1/4 NPT	
Q	1/4 NF		1/4 NF		5/16 NF		5/16 NF		3/8 NF		3/8 NF		3/8 NF		3/8 NF	
R	0.25	6	0.25	6	0.31	7.9	0.31	7.9	0.5	13	0.5	13	0.5	13	0.5	13

Consult factory for mounting hole and bottom port locations.

VM CO-ORDINATES

2 & 3-STATION FOR TWO-WAY VALVES

Three-Way valves may be intermixed on the same manifold.

(4 or more valve stations can be provided by joining multiples of the 2 or 3-station)

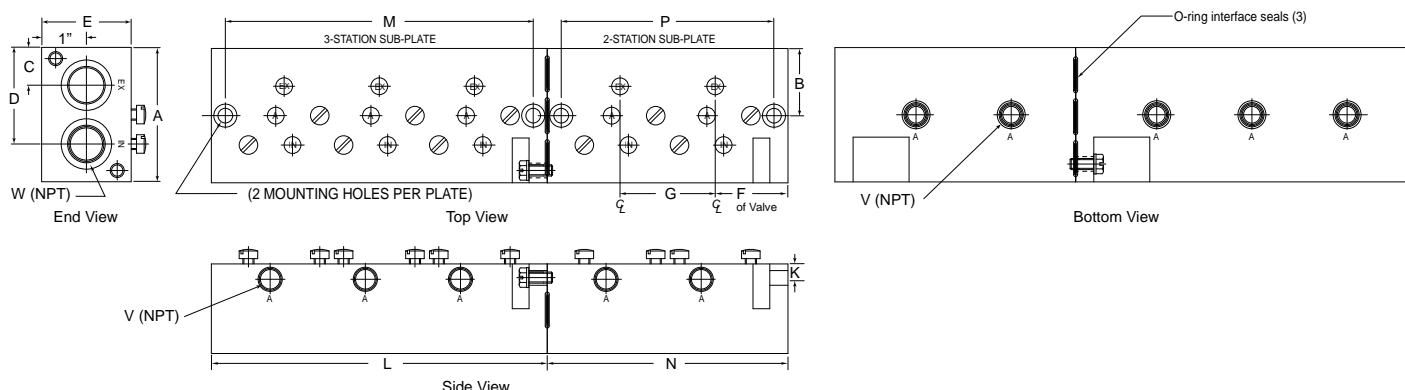

Dotted extension shows detail for 3-Station Co-Ordinate.

Pilot Manifold Adapter plates are available for mounting pilot valves with manifold mounted pilot ports. Consult factory.

DIMENSIONS - Inches (mm)

Drawing Key	A	B	C	D	E	F	G	K	L	M	N	P	V	W
For 1/4" Valves	3 (76)	1.5 (38)	0.84 (21)	2.16 (55)	2 (51)	1.63 (41)	2.13 (54)	0.34 (9)	7.5 (191)	6.88 (175)	5.38 (137)	4.75 (121)	0.25"	0.5"
For 1/2" Valves	4 (102)	2 (51)	1 (25)	3 (76)	2.5 (64)	2 (51)	3 (76)	0.5 (13)	10 (254)	9.38 (238)	7 (178)	6.38 (162)	0.5"	1"
Key letters A-K refer to sizes common to both 2 and 3-Station Co-Ordinates									3-Station Co-Ordinates only		2-Station Co-Ordinates only		Common Port sizes.	

HOW TO ORDER CO-ORDINATES

Product numbers shown are for Co-Ordinates only. Valves and accessories are ordered separately.

For help in specifying required valves refer to pages 12 and 13.

When Two-Way and Three-Way valves are to be mounted on the same manifold, a BLIND PLUG is required for each of the unused Two-Way exhaust ports on the mounting face of the Co-Ordinate. These plugs are assembled, but must be ordered separately as follows: VM-BP-43 for 1/4" size valves; VM-BP-45 for 1/2" size.

Valve Size	NPT Co-Ordinate Product No.
1/4"	VM-333-**
1/2"	VM-353-**

Accessories	Valve Size	
	1/4"	1/2"
Pilot Manifold Adapter	VM-PM-33	VM-PM-35
†Station Blank	SB-33	SB-35

** Insert No. of valve mounting stations required. Example: A 5 station Co-Ordinate for 1/2" Valves is VM-353-5 with NPT threads.

† Required to block and protect any unused or "future" valve mounting stations.

3

WAY VALVES 3/2 and 3/3

Three-Way Valves may be either normally open or normally closed to the inlet in the unactuated position. Three-Way Valves are usually used to control single acting cylinders or the pilots of other valves or devices.

Two additional types of Three-Way Valves are available.

Diverter: a common inlet that directs flow to either one of two outlets.

Selector: two separate inlets that are alternately connected to a common outlet.

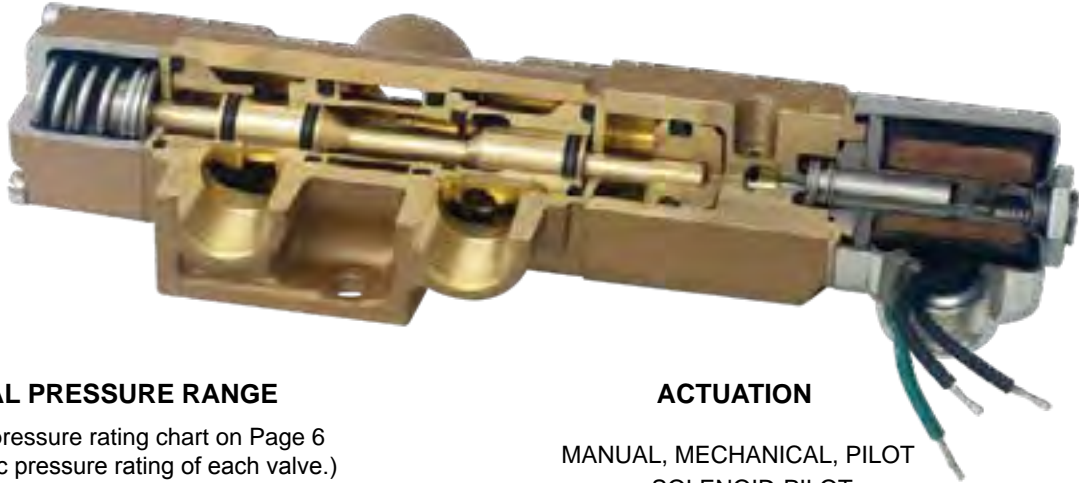

NOMINAL PRESSURE RANGE

(Consult pressure rating chart on Page 6 for specific pressure rating of each valve.)

Series "V": partial vacuum to 200 psi (14 bar) pneumatic

Series "T": 0-500 psi (35 bar) hydraulic

ACTUATION

MANUAL, MECHANICAL, PILOT
or SOLENOID-PILOT

BODY TYPES:

All Series "V" & "T" Three-Way Valves are available in the two body types described below. Actuators used with either body type are completely interchangeable.

SIDE-PORTED

The side-ported body provides threaded ports in the body of the valve.



PORT SIZES: 1/8, 1/4, 3/8, 1/2, 3/4, and 1 NPT
1/8, 1/4, 3/8, and 1/2 G

SUB-PLATE MOUNTING

The Sub-plate mounting valve is shown mounted on an individual sub-plate. See page 32 for details on the sub-plate.



PORT SIZES: 1/8, 1/4, 3/8, 1/2, 3/4, 1, 1-1/4 NPT and G

SPECIFICATIONS

Refer to pages 3 through 11 for information concerning:

Construction	Pressure Ranges
Seals	Electrical
Port Sizes	Temperature
Flow	Filtration & Lubrication

STANDARD FLOW PATTERNS

Valves must be connected in accordance with the port markings so that the flow is from the inlet port to the outlet port or from outlet port to exhaust. The flow within the valve should never be reversed. Note: When used in a vacuum system, the vacuum pump is connected to the exhaust port

THREE WAY

2 POSITION 3/2

1. VALVE NORMALLY CLOSED (actuator mounted on right end of valve)

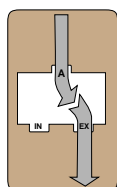

UNACTUATED

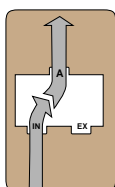

ACTUATED

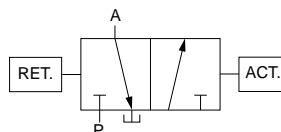

2. VALVE NORMALLY OPEN (actuator mounted on left end of valve)

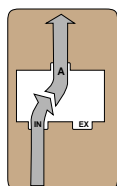

UNACTUATED

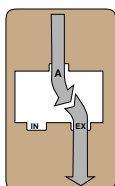

ACTUATED

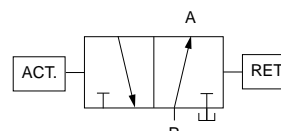

3 POSITION 3/3 (all ports blocked in the center position)

To indicate substitute number "3" for fourth digit of product number. Otherwise Product Number and offset flow patterns remain the same.

TWO OUTLET (Diverter)

To indicate substitute number "7" for first digit of product number.

2 POSITION 3/2

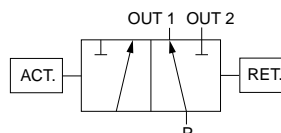
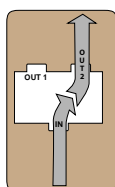
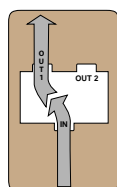

3 POSITION 3/3 (all ports blocked in the center position)

To indicate substitute number "3" for fourth digit of product number. Otherwise Product Number and offset flow patterns remain the same.

TWO INLET (Selector)

To indicate substitute number "8" for first digit of product number.

2 POSITION 3/2

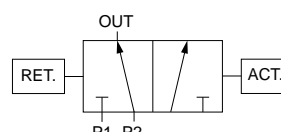
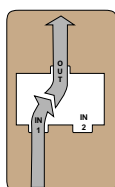
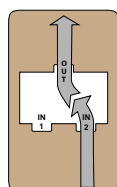

3 POSITION 3/3 (all ports blocked in the center position)

To indicate substitute number "3" for fourth digit of product number. Otherwise Product Number and offset flow patterns remain the same.

3

WAY-MOUNTING DIMENSIONS

Port hole locations and mounting hole size and locations shown in the individual Body Detail below apply to all Three-Way valves, regardless of type of actuation. The overall dimensions shown for each type of valve actuation apply whether for side ported or sub-plate mounting type.

BODY DETAIL

SIDEPORTED

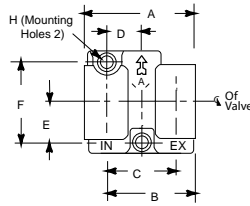

SUBPLATE MOUNTING

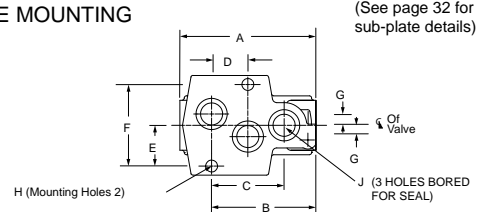

(See page 32 for sub-plate details)

SIZE	A		B		C		D		E		F		G		H Ø		J Ø	
	in	mm	in	mm	in	mm	in	mm	in	mm	in	mm	in	mm	in	mm	in	mm
1/8-1/4 SIDE PORTED or SUB-PLATE MOUNTING	2.19	56	1.75	45	1.31	33	0.66	17	.80	20	1.59	40	0.19	5	0.25	6.5	0.38	9.7
3/8-1/2 SIDE PORTED or SUB-PLATE MOUNTING	3.75	95	2.88	73	2	51	1	25	1.13	29	2.25	57	0.31	7.9	0.328	8	0.56	14
3/4-1 SIDE PORTED or SUB-PLATE MOUNTING	5.5	140	4.25	108	3	76	1.5	38	1.56	40	3.13	79	0.44	11.2	0.39	10	1	25
1-1/4 SIDE PORTED or SUB-PLATE MOUNTING	5.5	140	4.25	108	3	76	1.5	38	1.56	40	3.13	79	0.44	11.2	0.39	10	1.25	32

HAND ACTUATED VALVES

OFFSET LEVER TYPE

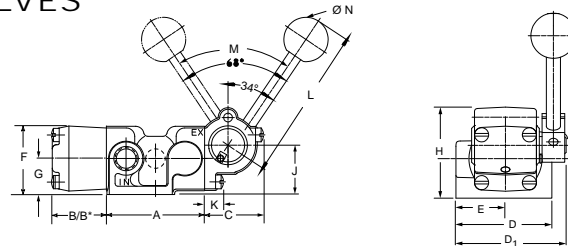

SIZE	A		B		B*		C		D1		D		E		F		G		H		J		K		L		M		N Ø	
	in	mm	in	mm	in	mm	in	mm	in	mm	in	mm	in	mm	in	mm	in	mm	in	mm	in	mm	in	mm	in	mm	°	in	mm	
1/8-1/4	2.19	56	1.22	31	1.84	47	1.34	34	2.31	59	2	51	1	25	1.5	38	0.81	21	2	51	1.13	29	0.53	13	3	76	68	1	25	
3/8-1/2	3.75	95	1.22	31	1.84	47	1.34	34	2.75	70	2.75	70	1.38	35	1.69	43	0.88	22	2.06	52	1.19	30	0.53	13	3	76	68	1	25	
3/4-1	5.5	140	2.06	52	3.22	82	2	51	3.75	95	3.75	95	1.88	48	2.44	62	1.25	32	2.97	75	1.72	44	0.81	21	5	127	62	1.25	32	

*Dimensions for Spring-Centering Valves

CENTERLINE LEVER TYPE

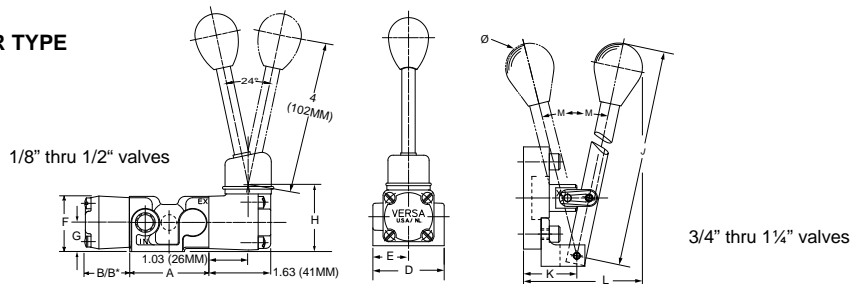

SIZE	A		B		B*		D		E		F		G		H		J		K		L		M	
	in	mm	in	mm	in	mm	in	mm	in	mm	in	mm	in	mm	in	mm	in	mm	in	mm	in	mm	°	
1/8-1/4	2.19	56	1.22	31	1.84	47	2	51	1	25	1.5	38	0.81	21	1.81	46	—	—	—	—	—	—	—	—
3/8-1/2	3.75	95	1.22	31	1.84	47	2.75	70	1.38	35	1.69	43	0.88	22	1.88	48	—	—	—	—	—	—	—	—
3/4-1	5.5	140	2.06	52	3.22	82	3.75	95	1.88	48	2.44	62	1.25	32	—	—	8	203	1.31	33	3.75	95	13	
1-1/4†	5.5	140	2.06	52	2.38	61	3.75	95	1.88	48	2.44	62	1.25	32	—	—	8.88	225	2.31	59	5.69	145	18.5	

*Dimensions for Spring-Centering Valves

†1 1/4" size valve has internal capacity of 1 1/4" (32mm) diameter. Sideported valves have 1" NPT ports; subplate for subplate mounting style has 1 1/4" NPT ports.

BUTTON ACTUATED VALVES

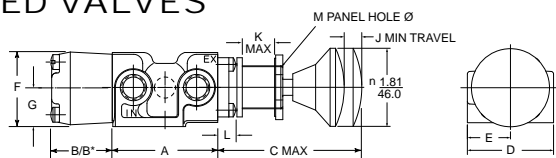

SIZE	A		B		B*		C		D		E		F		G		J		K		L		M	
	in	mm	in	mm	in	mm	in	mm	in	mm	in	mm	in	mm	in	mm	in	mm	in	mm	in	mm	in	mm
1/8-1/4	2.19	56	1.22	31	1.84	47	3.25	83	2	51	1	25	1.5	38	0.81	21	0.38	9.7	0.75	19	0.53	13	1	25
3/8-1/2	3.75	95	1.22	31	1.84	47	3.25	83	2.75	70	1.38	35	1.69	43	0.88	22	0.38	9.7	0.75	19	0.53	13	1	25
3/4-1	5.5	140	2.06	52	—	—	4.34	110	3.75	95	1.88	48	2.44	62	1.25	32	0.59	15	1.38	35	0.69	18	1.38	35

*Dimensions for Spring-Centering Valves

FOOT ACTUATED VALVES/PEDAL and TREADLE

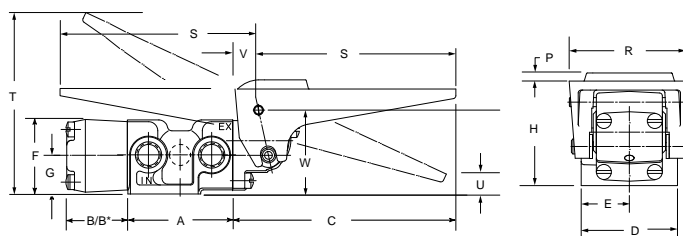

SIZE	A		B		B*		C		D		E		F		G		H		P		R		S		T		U		V		W	
	in	mm	in	mm	in	mm	in	mm	in	mm	in	mm	in	mm	in	mm	in	mm	in	mm	in	mm	in	mm	in	mm	in	mm	in	mm		
1/8-1/4	2.19	56	1.22	31	1.84	47	4.53	115	2	51	1	25	1.5	38	0.81	21	2.13	54	0.19	5	2.5	64	4	102	3.79	96	0.38	9.7	0.5	13	1.75	45
3/8-1/2	3.75	95	1.22	31	1.84	47	4.53	115	2.75	70	1.38	35	1.69	43	0.88	22	2.19	56	0.19	5	2.5	64	4	102	3.94	100	0.44	11	0.5	13	1.81	46
3/4-1	5.5	140	2.06	52	3.22	82	4.81	122	3.75	95	1.88	48	2.44	62	1.25	32	3.19	81	.25	6	3.63	92	4	102	5	127	1	25	0.63	16	2.69	68

*Dimensions for Spring-Centering Valves

CAM ACTUATED VALVES

NORMAL DUTY

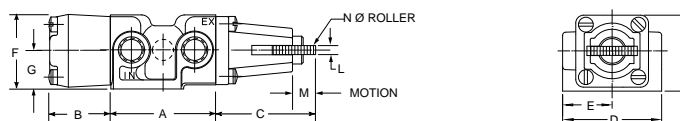

SIZE	A		B		C		D		E		F		G		L		M		N	
	in	mm	in	mm	in	mm	in	mm	in	mm	in	mm	in	mm	in	mm	in	mm	in	mm
1/8-1/4	2.19	56	1.22	31	2	51	2	51	1	25	1.5	38	0.81	21	0.19	5	0.38	9.7	0.88	22
3/8-1/2	3.75	95	1.22	31	2	51	2.75	70	1.38	35	1.69	43	0.88	22	0.19	5	0.38	9.7	0.88	22
3/4-1	5.5	140	2.06	52	3.22	82	3.75	95	1.88	48	2.44	62	1.25	32	0.31	7.9	0.63	16	1.25	32

HEAVY DUTY

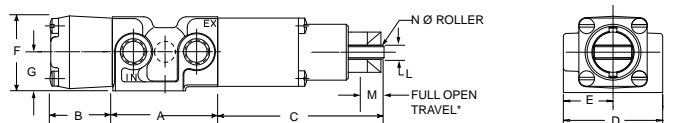

SIZE	A		B		C		D		E		F		G		L		M		N	
	in	mm	in	mm	in	mm	in	mm	in	mm	in	mm	in	mm	in	mm	in	mm	in	mm
1/8-1/4	2.19	56	1.22	31	3.34	85	2	51	1	25	1.5	38	0.81	21	0.28	7	.4	10	0.75	19
3/8-1/2	3.75	95	1.22	31	3.34	85	2.75	70	1.38	35	1.69	43	0.88	22	0.28	7	.4	10	0.75	19

*Maximum Permissible Over-Travel — 1/4" (6.4mm)

Refer to page 28 under Body Detail, for port and mounting hole locations for all valves shown above.

3

WAY-MOUNTING DIMENSIONS

PILOT ACTUATED VALVES (and Spring Centering)

SINGLE PILOT

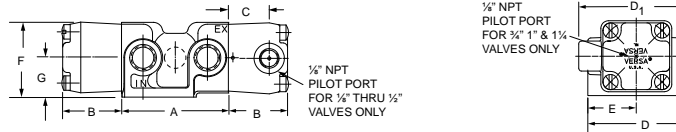

DOUBLE PILOT

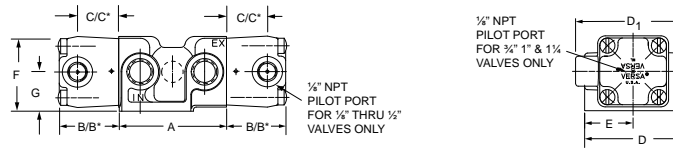

SIZE	A		B		B*		C		C*		D1		D		E		F		G	
	in	mm	in	mm	in	mm	in	mm	in	mm	in	mm	in	mm	in	mm	in	mm	in	mm
1/8-1/4	2.19	56	1.22	31	2.13	54	0.84	21	1.73	44	2.19	56	2.0	51	1	25	1.5	38	0.81	21
3/8-1/2	3.75	95	1.22	31	2.13	54	0.84	21	1.73	44	2.69	68	2.75	70	1.38	35	1.69	43	0.88	22
3/4-1-1 1/4†	5.5	140	2.06	52	3.53	90	—	—	—	—	—	—	3.75	95	1.88	48	2.44	62	1.25	32

*Dimensions for Spring-Centering Valves

DIAPHRAGM ACTUATED VALVES (and Spring Centering)

SINGLE DIAPHRAGM

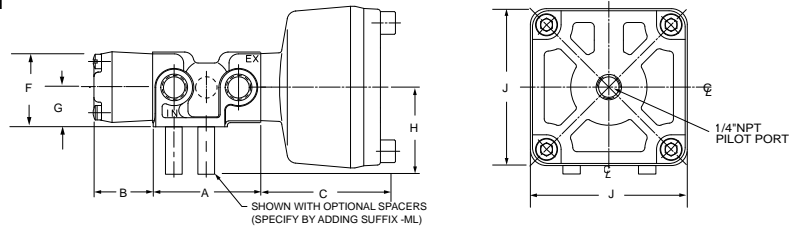

DOUBLE DIAPHRAGM

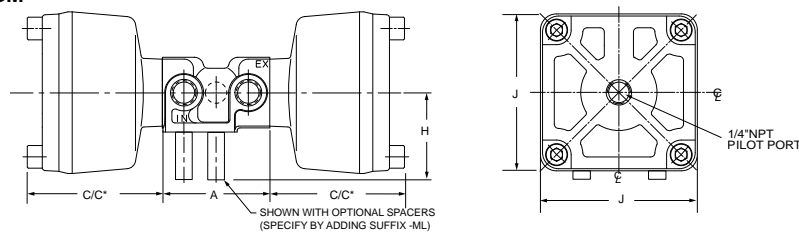

SIZE	A		B		C		C*		F		G		H		J	
	in	mm	in	mm	in	mm	in	mm	in	mm	in	mm	in	mm	in	mm
1/8-1/4	2.19	56	1.22	31	2.75	70	2.84	72	1.5	38	0.81	21	1.69	43	3.34	85
3/8-1/2	3.75	95	1.22	31	2.75	70	2.84	72	1.69	43	0.88	22	1.75	45	3.34	85
3/4-1	5.5	140	2.06	52	2.97	75	3.69	94	2.44	62	1.25	32	1.75	45	3.25	83
1-1/4†	5.5	140	2.06	52	3.22	82	3.94	100	2.44	62	1.25	32	1.75	45	3.25	83

*Dimensions for Spring-Centering Valves

Refer to page 28 under Body Detail, for port and mounting hole locations for all valves shown above.

1 1/4" size valve has internal capacity of 1 1/4" (32mm) diameter. Sideported valves have 1" NPT ports; subplate for subplate mounting style has 1 1/4" NPT ports

SOLENOID ACTUATED VALVES/INLINE (Non Hazardous Service Valves)

SINGLE SOLENOID

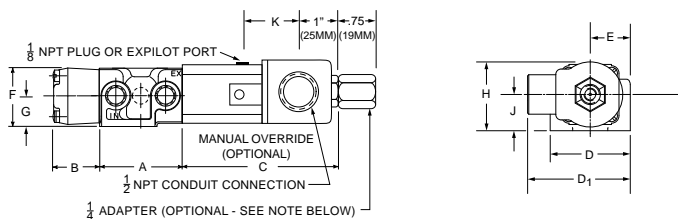

DOUBLE SOLENOID

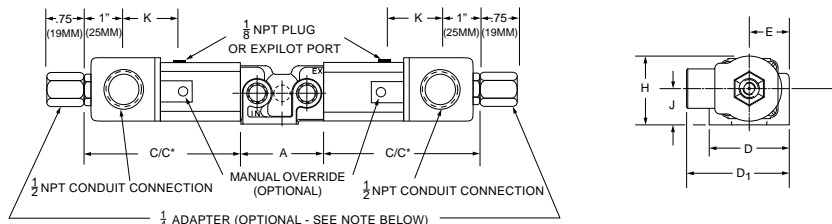

SIZE	A	B	C	C*	D1	D	E	F	G	H	J	K
	in mm	in mm	in mm	in mm	in mm	in mm	in mm	in mm	in mm	in mm	in mm	in mm
1/8-1/4	2.19 56	1.22 31	3.94 100	4.84 123	2.56 65	2 51	1 25	1.5 38	0.81 21	1.72 44	0.91 23	1.63 41
3/8-1/2	3.75 95	1.22 31	3.94 100	4.84 123	2.94 75	2.75 70	1.38 35	1.69 43	0.88 22	1.78 45	0.97 25	1.63 41
3/4-1-1/4†	5.5 140	2.06 52	4.5 114	5.97 152	3.44 87	3.75 95	1.88 48	2.44 62	1.25 32	2 62	1.25 32	1.41 36

*Dimensions for Spring-Centering Valves

NOTE: Adapter is supplied when specified, by adding suffix "-H" to product number

SOLENOID ACTUATED VALVES/UPRIGHT (Non Hazardous Service Valves. For hazardous service valves see Page 9 - 11.)

SINGLE SOLENOID

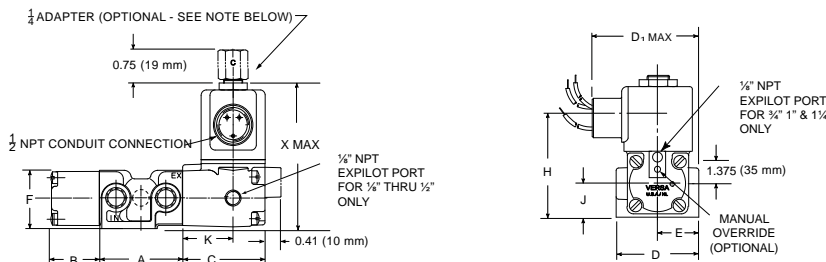

DOUBLE SOLENOID

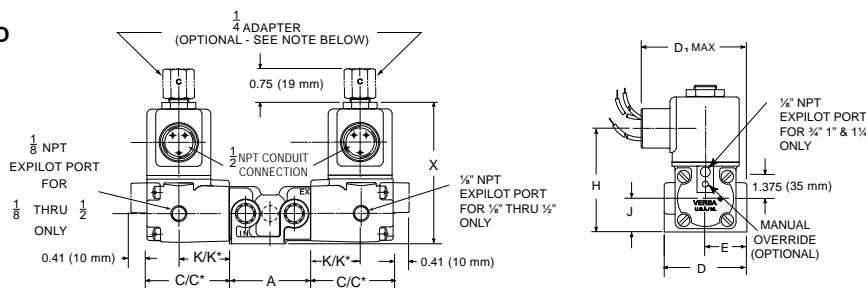

SIZE	A	B	C	C*	D1	D	E	F	H	J	K	K*	X
	in mm	in mm	in mm	in mm	in mm	in mm	in mm	in mm	in mm	in mm	in mm	in mm	in mm
1/8-1/4	2.19 56	1.22 31	2.09 53	3 76	2.5 64	2 51	1 25	1.5 38	2.59 66	0.81 21	1.28 33	2.19 56	3.81 97
3/8-1/2	3.75 95	1.22 31	2.09 53	3 76	2.88 73	2.75 70	1.38 35	1.69 43	2.66 68	0.88 22	1.28 33	2.19 56	3.88 99
3/4-1-1/4†	5.5 140	2.06 52	2 51	3.47 88	3.44 87	3.75 95	1.88 48	2.44 62	3.91 99	1.25 32	1 25	2.5 64	5.16 131

*Dimensions for Spring-Centering Valves

NOTE: Adapter is supplied when specified, by adding suffix "-H" to product number

Refer to page 28 under Body Detail, for port and mounting hole locations for all valves shown above.
 †1 1/4" size valve has internal capacity of 1 1/4" (32mm) diameter. Sideported valves have 1" NPT ports; subplate for subplate mounting style has 1 1/4" NPT ports.

SUB-PLATES (SINGLE STATION TYPE)

Will mount series "V" or "T" sub-plate type valves. Multiple valve station manifolds (VM Co-Ordinates) for the mounting of several valves are also available. See page 33. For sub-plates to mount plug-in solenoids, consult factory.

FOR THREE-WAY VALVES

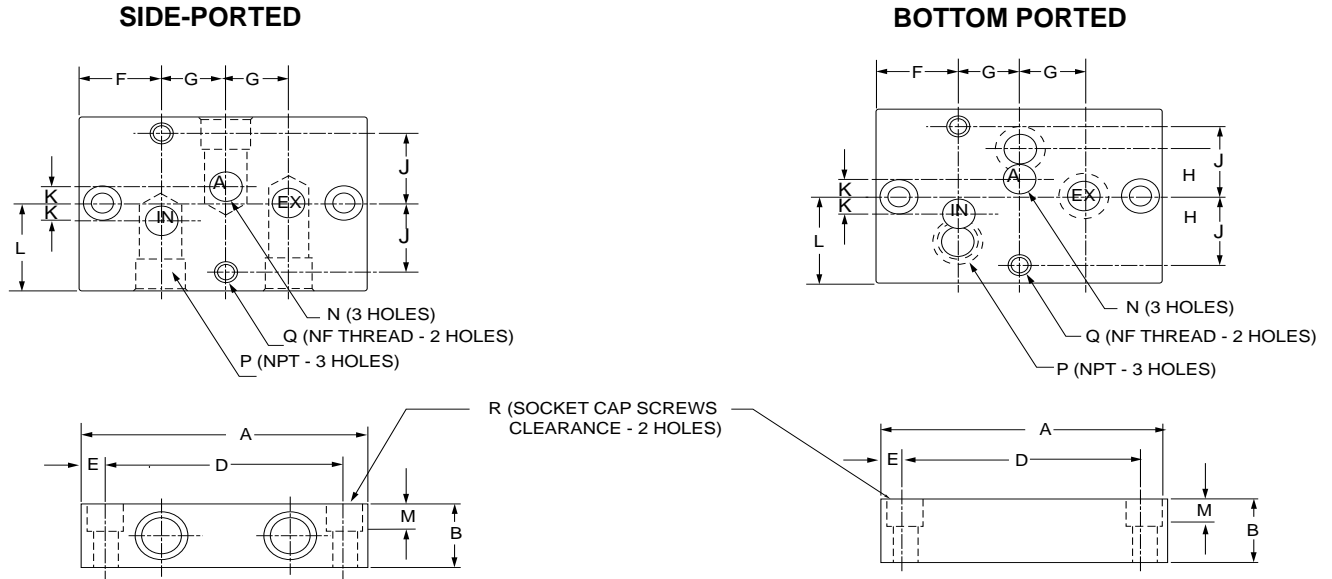

SUB-PLATE PRODUCT NUMBERS *Product numbers shown provide NPT ports. For ports with G thread add Suffix-2B.	Side Ported	M-320-A	M-330-A	M-340-A	M-350-A	M-360-A	M-370-A	M-370-A-12	—						
	Bottom Ported	M-321-A	M-331-A	M-341-A	M-351-A	M-361-A	M-371-A	—	M-371-A-12						
VALVE SIZE	1/8	1/4		3/8		1/2		3/4		1		1 1/4		1 1/4	
	in mm	in mm	in mm	in mm	in mm	in mm	in mm	in mm	in mm	in mm	in mm	in mm	in mm	in mm	in mm
A	3 76	3 76	4 102	4 102	6.125 156	6.125 156	6.125 156	6.125 156	6.125 156	6.125 156	6.125 156	6.125 156	6.125 156	6.125 156	6.125 156
B	0.75 19	0.75 19	1.25 32	1.25 32	2 51	2 51	2 51	2.5 64	2 51	2 51	2.5 64	2 51	2 51	2 51	2 51
C	2 51	2 51	3 76	3 76	4 102	4 102	4 102	4 102	4 102	4 102	4 102	4 102	4 102	4 102	4 102
D	2.5 64	2.5 64	3.38 87	3.38 86	5.25 133	5.25 133	5.25 133	See note below							
E	0.25 6	0.25 6	0.31 7.9	0.31 7.9	0.44 11	0.44 11	0.44 11	0.44 11	0.44 11	0.44 11	0.44 11	0.44 11	0.44 11	0.44 11	0.44 11
F	0.84 21	0.84 21	1 25	1 25	1.56 40	1.56 40	1.56 40	1.56 40	1.56 40	1.56 40	1.56 40	1.56 40	1.56 40	1.56 40	1.56 40
G	0.66 17	0.66 17	1 25	1 25	1.5 38	1.5 38	1.5 38	1.5 38	1.5 38	1.5 38	1.5 38	1.5 38	1.5 38	1.5 38	1.5 38
H	0.375 10	0.375 10	0.625 16	0.625 16	1 25	1 25	1 25	1.25 32	—	—	—	—	—	—	—
J	0.78 20	0.78 20	1.125 29	1.125 29	1.56 40	1.56 40	1.56 40	See note below							
K	0.19 5	0.19 5	0.31 7.9	0.31 7.9	0.44 11	0.44 11	0.44 11	0.44 11	0.44 11	0.44 11	0.44 11	0.44 11	0.44 11	0.44 11	0.44 11
L	1 25	1 25	1.5 38	1.5 38	2 51	2 51	2 51	2 51	2 51	2 51	2 51	2 51	2 51	2 51	2 51
M	0.5 13	0.5 13	0.75 19	0.75 19	1 25	1 25	—	—	1 25	—	—	1 25	—	—	1 25
N	0.375 10	0.375 10	.625 16	.625 16	1 25	1 25	1 25	1 25	1 25	1 25	1 25	1.25 32	1.25 32	1.25 32	1.25 32
* P	1/8 NPT	1/4 NPT	3/8 NPT	1/2 NPT	3/4 NPT	1 NPT	1 1/4 NPT	1 1/4 NPT	1 1/4 NPT	1 1/4 NPT	1 1/4 NPT	1 1/4 NPT	1 1/4 NPT	1 1/4 NPT	1 1/4 NPT
Q	1/4 NF	1/4 NF	5/16 NF	5/16 NF	3/8 NF	3/8 NF	3/8 NF	3/8 NF	3/8 NF	3/8 NF	3/8 NF	3/8 NF	3/8 NF	3/8 NF	3/8 NF
R	0.25 6	0.25 6	0.31 7.9	0.31 7.9	0.5 13	0.5 13	0.5 13	0.5 13	0.5 13	0.5 13	0.5 13	0.5 13	0.5 13	0.5 13	0.5 13

Consult factory for mounting hole and bottom port locations.

VM CO-ORDINATES

2 & 3-STATION FOR THREE-WAY VALVES

Three-Way valves may be intermixed on the same manifold.

(4 or more valve stations can be provided by joining multiples of the 2 or 3-station)

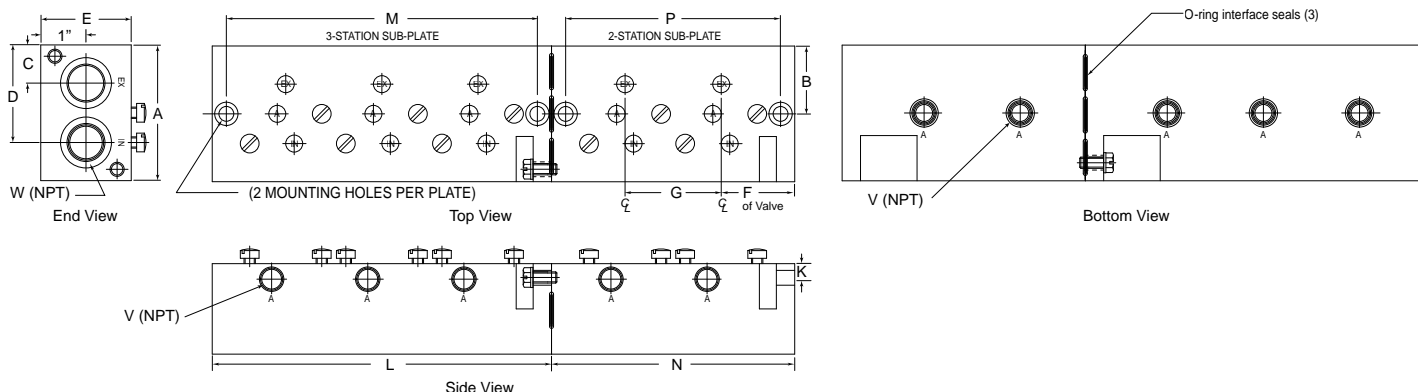

Bleed Control or Pilot Manifold Adapter plates are available. Consult factory.

DIMENSIONS - Inches (mm)

Drawing Key	A	B	C	D	E	F	G	K	L	M	N	P	V	W
For 1/4" Valves	3 (76)	1.5 (38)	0.84 (21)	2.16 (55)	2 (51)	1.63 (41)	2.13 (54)	0.34 (9)	7.5 (191)	6.88 (175)	5.38 (137)	4.75 (121)	0.25"	0.5"
For 1/2" Valves	4 (102)	2 (51)	1 (25)	3 (76)	2.5 (64)	2 (51)	3 (76)	0.5 (13)	10 (254)	9.38 (238)	7 (178)	6.38 (162)	0.5"	1"
Key letters A-K refer to sizes common to both 2- and 3-Station Co-Ordinates									3-Station Co-Ordinates only		2-Station Co-Ordinates only		Common Port sizes.	

HOW TO ORDER CO-ORDINATES

Product numbers shown are for Co-Ordinates only. Valves and accessories are ordered separately.

For help in specifying required valves refer to pages 12 and 13.

When Two-Way and Three-Way valves are to be mounted on the same manifold, a BLIND PLUG is required for each of the unused Two-Way exhaust ports on the mounting face of the Co-Ordinate. These plugs are assembled, but must be ordered separately as follows: VM-BP-43 for 1/4" size valves; VM-BP-45 for 1/2" size.

Valve Size	NPT Co-Ordinate Product No.
1/4"	VM-333-**
1/2"	VM-353-**

ACCESSORIES	Valve Size	
	1/4"	1/2"
Bleed Control Adapter	VM-BC-33	VM-BC-35
Pilot Manifold Adapter	VM-PM-33	VM-PM-35
Bleed Control & Pilot Manifold Adapter	VM-BC-33-30	VM-BC-35-30
†Station Blank	SB-33	SB-35

** Insert No. of valve mounting stations required. Example: A 5 station Co-Ordinate for 1/2" Valves is VM-353-5 with NPT threads.

† Required to block and protect any unused or "future" valve mounting stations.

4

WAY VALVES 5/2 and 5/3

Four-Way Valves are generally used to control double acting cylinders. They function to alternately direct pressure to one of two outlets at the same time exhausting pressure from the opposite outlet.



NOMINAL PRESSURE RANGE

(Consult pressure rating chart on Page 6 for specific pressure rating of each valve.)

Series "V": partial vacuum to 200 psi (14 bar) pneumatic

Series "T": 0-500 psi (35 bar) hydraulic

ACTUATION

MANUAL, MECHANICAL, PILOT
or SOLENOID-PILOT

BODY TYPES:

All Series "V" & "T" Four-Way Valves are available in the two body types described below. Actuators used with either body type are completely interchangeable.

SIDE-PORTED

The side-ported body provides threaded ports in the body of the valve.



PORT SIZES: 1/8, 1/4, 3/8, 1/2, 3/4, and 1 NPT
1/8, 1/4, 3/8, and 1/2 G

SUB-PLATE MOUNTING

The Sub-plate mounting valve is shown mounted on an individual sub-plate. See page 40 for details on the sub-plate.



PORT SIZES: 1/8, 1/4, 3/8, 1/2, 3/4, 1, 1-1/4 NPT and G

SPECIFICATIONS

Refer to pages 3 through 11 for information concerning:

- Construction
- Seals
- Port Sizes
- Flow
- Pressure Ranges
- Electrical
- Temperature
- Filtration & Lubrication

STANDARD FLOW PATTERNS

ONE INLET, TWO OUTLETS, TWO EXHAUSTS

Valves must be connected in accordance with the port markings so that the flow is from the inlet port to the outlet port or from outlet port to exhaust. The flow within the valve should never be reversed. Note: When used in a vacuum system, the vacuum pump is connected to the outlet port

TWO POSITION 5/2

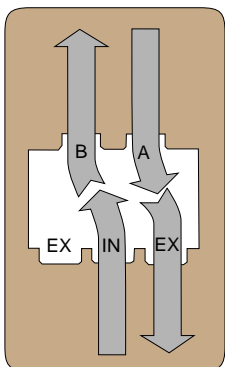

Inlet open to cylinder port B, cylinder port A, open to exhaust.

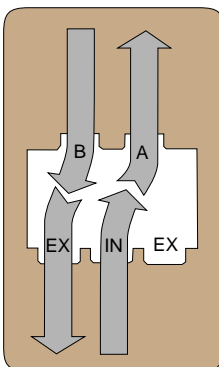

Inlet open to cylinder port A, cylinder port B open to exhaust.

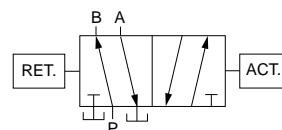

3 POSITION 5/3 Diagrams below show center position only. Offset positions are same as shown above for 2-position types. To indicate particular center pattern required, substitute number shown within corresponding diagram for fourth digit of product number.

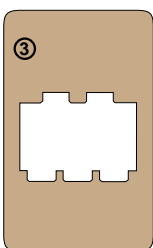

All ports blocked

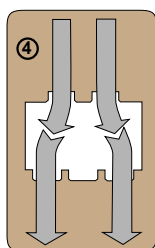

Cylinder ports open to exhaust.

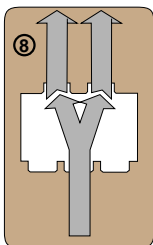

Inlet open to both cylinder ports.

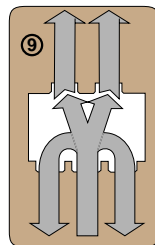

All ports open.

4

WAY-MOUNTING DIMENSIONS

Port hole locations and mounting hole size and locations shown in the individual Body Detail below apply to all Four-Way valves, regardless of type of actuation. The overall dimensions shown for each type of valve actuation apply whether for side ported or sub-plate mounting type.

BODY DETAIL

SIDEPORTED

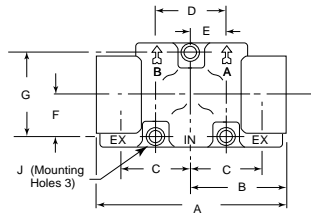

SUBPLATE MOUNTING

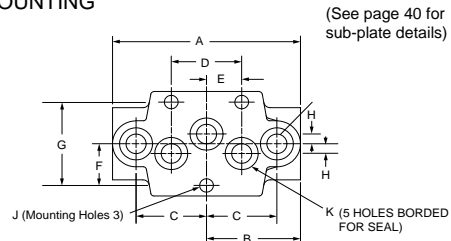

(See page 40 for sub-plate details)

SIZE	A	B	C	D	E	F	G	H	J Ø	K Ø										
	in	mm	in	mm	in	mm	in	mm	in	mm										
1/8-1/4 SIDE PORTED or SUB-PLATE MOUNTING	3.5	89	1.75	45	1.31	33	1.31	33	0.66	17	0.8	20	1.59	40	0.19	5	0.25	6	0.38	9.7
3/8-1/2 SIDE PORTED or SUB-PLATE MOUNTING	5.75	146	2.88	73	2	51	2	51	1	25	1.13	29	2.25	57	0.31	7.9	0.32	8	0.56	14
3/4-1 SIDE PORTED or SUB-PLATE MOUNTING	8.5	216	4.25	108	3	76	3	76	1.5	38	1.56	40	3.13	79	0.44	11.2	0.39	10	1	25
1-1/4† SIDE PORTED or SUB-PLATE MOUNTING	8.5	216	4.25	108	3	76	3	76	1.5	38	1.56	40	3.13	79	0.44	11.2	0.39	10	1.25	32

HAND ACTUATED VALVES

OFFSET LEVER TYPE

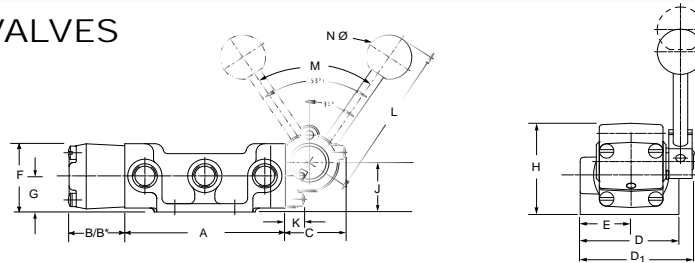

SIZE	A	B	B*	C	D1	D	E	F	G	H	J	K	L	M	N Ø														
	in	mm	in	mm	in	mm	in	mm	in	mm	in	mm	in	mm	°	in	mm												
1/8-1/4	3.5	89	1.22	31	1.84	47	1.34	34	2.31	59	2	51	1	25	1.5	38	0.81	21	2	51	1.13	29	0.53	13	3	76	68	1	25
3/8-1/2	5.75	146	1.22	31	1.84	47	1.34	34	2.75	70	2.75	70	1.38	35	1.69	43	0.88	22	2.06	52	1.19	30	0.53	13	3	76	68	1	25
3/4-1	85	216	2.06	52	3.22	82	2	51	3.75	95	3.75	95	1.88	48	2.44	62	1.25	32	2.97	75	1.72	44	.810	21	5	127	62	1.25	32

*Dimensions for Spring-Centering Valves

CENTERLINE LEVER TYPE

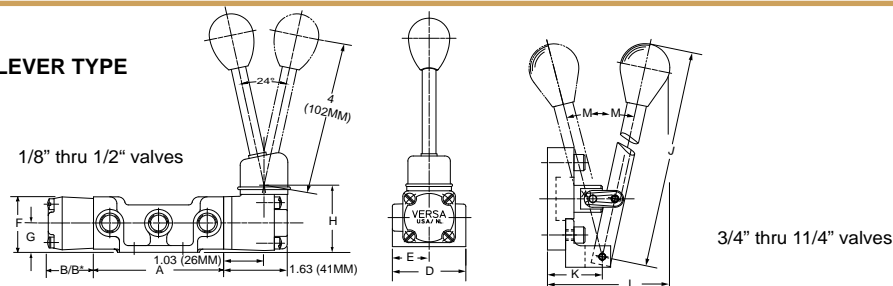

SIZE	A	B	B*	D	E	F	G	H	J	K	L	M											
	in	mm	in	mm	in	mm	in	mm	in	mm	in	mm	°										
1/8-1/4	3.5	89	1.22	31	1.84	47	2	51	1	25	1.5	38	0.81	21	1.81	46	—	—	—	—	—	—	—
3/8-1/2	5.75	146	1.22	31	1.84	47	2.75	70	1.38	35	1.69	43	0.88	22	1.88	48	—	—	—	—	—	—	—
3/4-1	8.5	216	2.06	52	3.22	82	3.75	95	1.88	48	2.44	62	1.25	32	—	—	8	203	1.31	33	3.75	95	13
1-1/4†	8.5	216	2.06	52	2.38	61	3.75	95	1.88	48	2.44	62	1.25	32	—	—	8.88	225	2.31	59	5.69	145	18.5

*Dimensions for Spring-Centering Valves

†1 1/4" size valve has internal capacity of 1 1/4" (32mm) diameter. Sideported valves have 1" NPT ports; subplate for subplate mounting style has 1 1/4" NPT ports.

BUTTON ACTUATED VALVES

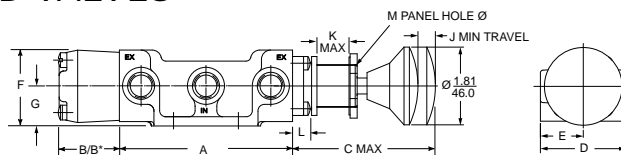

SIZE	A		B		B*		C		D		E		F		G		J		K		L		M	
	in	mm	in	mm	in	mm	in	mm	in	mm	in	mm	in	mm	in	mm	in	mm	in	mm	in	mm	in	mm
1/8-1/4	3.5	89	1.22	31	1.84	47	3.25	83	2	51	1	25	1.5	38	0.81	21	0.38	9.7	0.75	19	0.53	13	1	25
3/8-1/2	5.75	146	1.22	31	1.84	47	3.25	83	2.75	70	1.38	35	1.69	43	0.88	22	0.38	9.7	0.75	19	0.53	13	1	25
3/4-1 1/4	8.5	216	2.06	52	—	—	4.34	110	3.75	95	1.88	48	2.44	62	1.25	32	0.59	15	1.38	35	0.69	18	1.38	35

*Dimensions for Spring-Centering Valves

FOOT ACTUATED VALVES/PEDAL and TREADLE

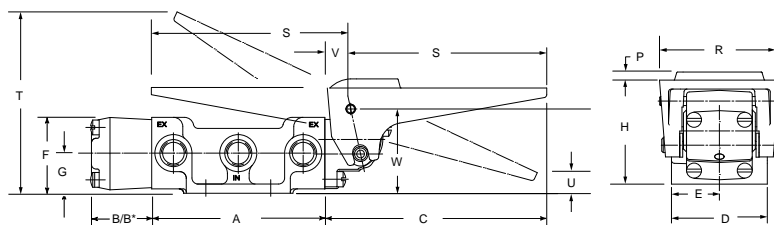

SIZE	A		B		B*		C		D		E		F		G		H		P		R		S		T		U		V		W	
	in	mm	in	mm	in	mm	in	mm	in	mm	in	mm	in	mm	in	mm	in	mm	in	mm	in	mm	in	mm	in	mm	in	mm	in	mm		
1/8-1/4	3.5	89	1.22	31	1.84	47	4.53	115	2	51	1	25	1.5	38	0.81	21	2.13	54	0.19	5	2.5	64	4	102	3	98	0.38	9.7	0.5	13	1.75	45
3/8-1/2	5.75	146	1.22	31	1.84	47	4.53	115	2.75	70	1.38	35	1.69	43	0.88	22	2.19	56	0.19	5	2.5	64	4	102	3	100	0.44	11	0.5	13	1.18	46
3/4-1	8.5	216	2.06	52	3.22	82	4.81	122	3.75	95	1.88	48	2.44	62	1.25	32	3.19	81	.25	6	3.63	92	4	102	5	127	1	25	0.63	16	2.69	68

*Dimensions for Spring-Centering Valves

CAM ACTUATED VALVES

NORMAL DUTY

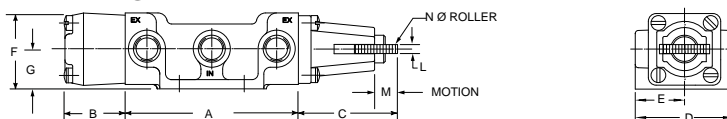

SIZE	A		B		C		D		E		F		G		L		M		N	
	in	mm	in	mm	in	mm	in	mm	in	mm	in	mm	in	mm	in	mm	in	mm	in	mm
1/8-1/4	3.5	89	1.22	31	2	51	2	51	1	25	1.5	38	0.81	21	0.19	5	0.38	9.7	0.88	22
3/8-1/2	5.75	146	1.22	31	2	51	2.75	70	1.38	35	1.69	43	0.88	22	0.19	5	0.38	9.7	0.88	22
3/4-1	8.5	216	2.06	52	3.22	82	3.75	95	1.88	48	2.44	62	1.25	32	0.31	7.9	0.63	16	1.25	32

HEAVY DUTY

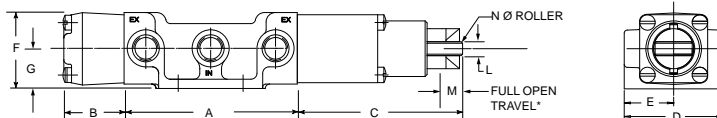

SIZE	A		B		C		D		E		F		G		L		M		N	
	in	mm	in	mm	in	mm	in	mm	in	mm	in	mm	in	mm	in	mm	in	mm	in	mm
1/8-1/4	3.5	89	1.22	31	3.34	85	2	51	1	25	1.5	38	0.81	21	0.28	7	.41	10	0.75	19
3/8-1/2	5.75	146	1.22	31	3.34	85	2.75	70	1.38	35	1.69	43	0.88	22	0.28	7	.41	10	0.75	19

*Maximum Permissible Over-Travel — 1/4" (6.4mm)

Refer to page 36 under Body Detail, for port and mounting hole locations for all valves shown above.

4

WAY-MOUNTING DIMENSIONS

PIILOT ACTUATED VALVES

SINGLE PILOT

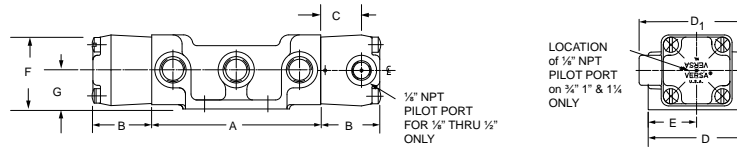

DOUBLE PILOT

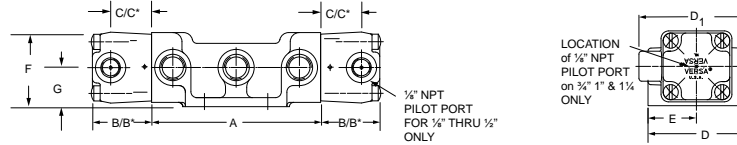

SIZE	A		B		B*		C		C*		D1		D		E		F		G	
	in	mm	in	mm	in	mm	in	mm	in	mm	in	mm	in	mm	in	mm	in	mm	in	mm
1/8-1/4	3.5	89	1.22	31	2.13	54	0.84	21	1.73	44	2.19	56	2	51	1	25	1.5	38	0.81	21
3/8-1/2	5.75	146	1.22	31	2.13	54	0.84	21	1.73	44	2.69	68	2.75	70	1.38	35	1.69	43	0.88	22
3/4-1-1/4†	8.5	216	2.06	52	3.53	90	—	—	—	—	—	—	3.75	95	1.88	48	2.44	62	1.25	32

*Dimensions for Spring-Centering Valves

DIAPHRAGM ACTUATED VALVES

SINGLE DIAPHRAGM

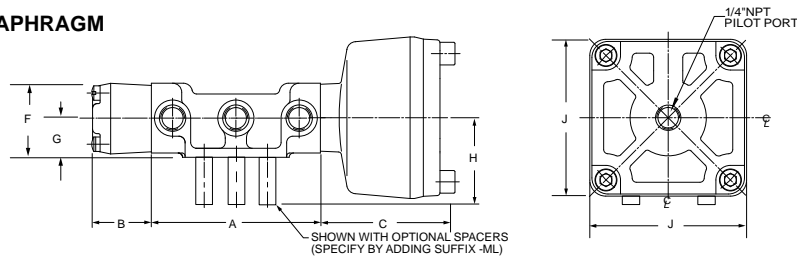

DOUBLE DIAPHRAGM

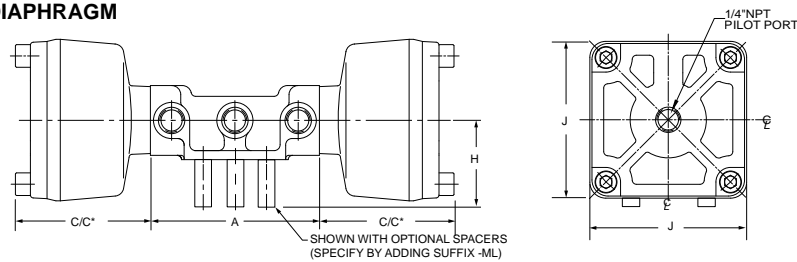

SIZE	A		B		C		C*		F		G		H		J	
	in	mm	in	mm	in	mm	in	mm	in	mm	in	mm	in	mm	in	mm
1/8-1/4	3.5	89	1.22	31	2.75	70	2.84	72	1.5	38	0.81	21	1.69	43	3.34	85
3/8-1/2	5.75	146	1.22	31	2.75	70	2.84	72	1.69	43	0.88	22	1.75	45	3.34	85
3/4-1	8.5	216	2.06	52	2.97	75	3.69	94	2.44	62	1.25	32	1.75	45	3.25	83
1-1/4†	8.5	216	2.06	52	3.22	82	3.94	100	2.44	62	1.25	32	1.75	45	3.25	83

*Dimensions for Spring-Centering Valves

Refer to page 36 under Body Detail, for port and mounting hole locations for all valves shown above.

†1 1/4" size valve has internal capacity of 1 1/4" (32mm) diameter. Sideported valves have 1" NPT ports; subplate for subplate mounting style has 1 1/4" NPT ports

SOLENOID ACTUATED VALVES/INLINE (Non Hazardous Service)

SINGLE SOLENOID

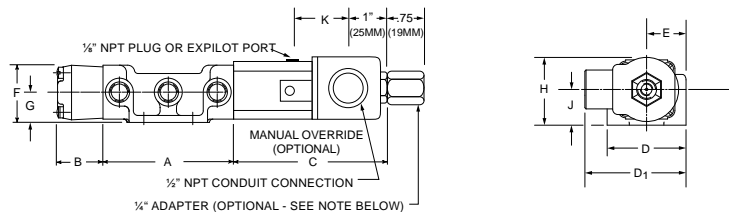

DOUBLE SOLENOID

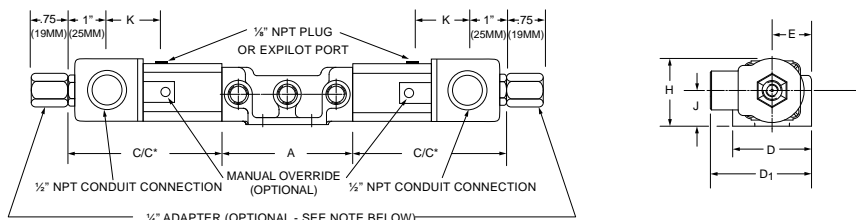

SIZE	A	B	C	C*	D1	D	E	F	G	H	J	K												
	in	mm	in	mm	in	mm	in	mm	in	mm	in	mm												
1/8-1/4	3.5	89	1.22	31	3.94	100	4.84	123	2.56	65	2	51	1	25	1.5	38	0.81	21	1.72	44	0.91	23	1.63	41
3/8-1/2	5.75	146	1.22	31	3.94	100	4.84	123	2.94	75	2.75	70	1.38	35	1.69	43	0.88	22	1.78	45	0.97	25	1.63	41
3/4-1-1/4†	8.5	216	2.06	52	4.5	114	5.97	152	3.44	87	3.75	95	1.88	48	2.44	62	1.25	32	2.44	62	1.25	32	1.41	36

*Dimensions for Spring-Centering Valves

NOTE: Adapter is supplied when specified, by adding suffix "-H" to product number

SOLENOID ACTUATED VALVES/UPRIGHT (Non Hazardous Service Valves. For hazardous service valves see Page 9 - 11.)

SINGLE SOLENOID

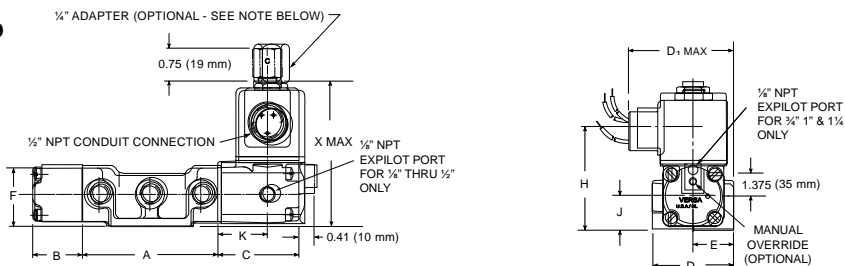

DOUBLE SOLENOID

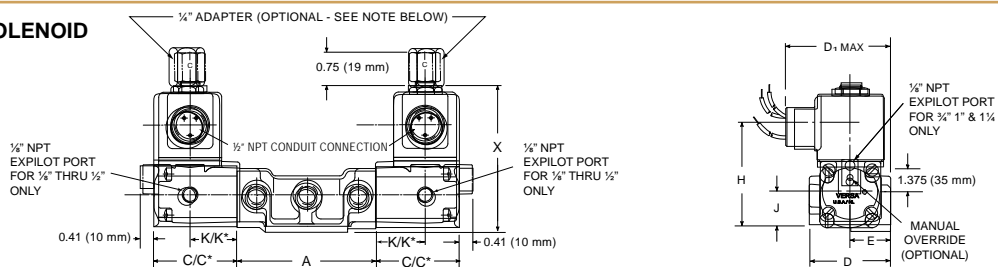

SIZE	A	B	C	C*	D1	D	E	F	H	J	K	K*	X													
	in	mm	in	mm	in	mm	in	mm	in	mm	in	mm	in	mm												
1/8-1/4	3.5	89	1.22	31	2.09	53	3	76	2.5	64	2	51	1	25	1.5	38	2.59	66	0.81	21	1.28	33	2.19	56	3.81	97
3/8-1/2	5.75	146	1.22	31	2.09	53	3	76	2.88	73	2.75	70	1.38	35	1.69	43	2.66	68	0.88	22	1.28	33	2.19	56	3.88	99
3/4-1-1/4†	8.5	216	2.06	52	2	51	3.47	88	3.44	86	3.75	95	1.88	48	2.44	62	3.91	99	1.25	32	1.25	25	2.5	64	5.16	131

*Dimensions for Spring-Centering Valves

NOTE: Adapter is supplied when specified, by adding suffix "-H" to product number

Refer to page 36 under Body Detail, for port and mounting hole locations for all valves shown above.
 †1 1/4" size valve has internal capacity of 1 1/4" (32mm) diameter. Sideported valves have 1" NPT ports; subplate for subplate mounting style has 1 1/4" NPT ports.

SUB-PLATES (SINGLE STATION TYPE)

Will mount series "V" or "T" sub-plate type valves. Multiple valve station manifolds (VM Co-Ordinates) for the mounting of several valves are also available. See page 41. For sub-plates to mount plug-in solenoids, consult factory.

FOR FOUR-WAY VALVES

SIDE-PORTED

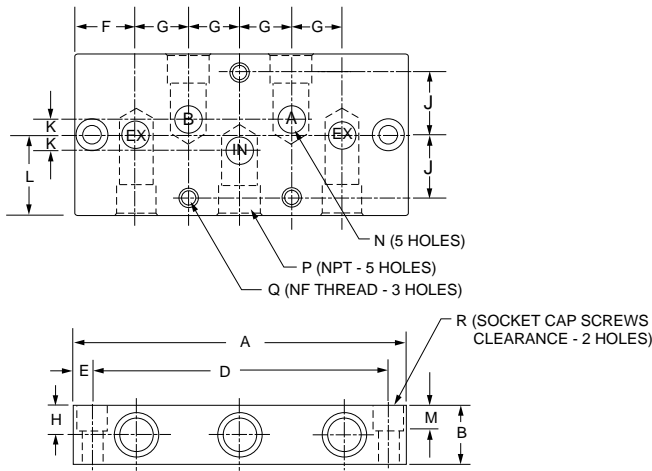

BOTTOM PORTED

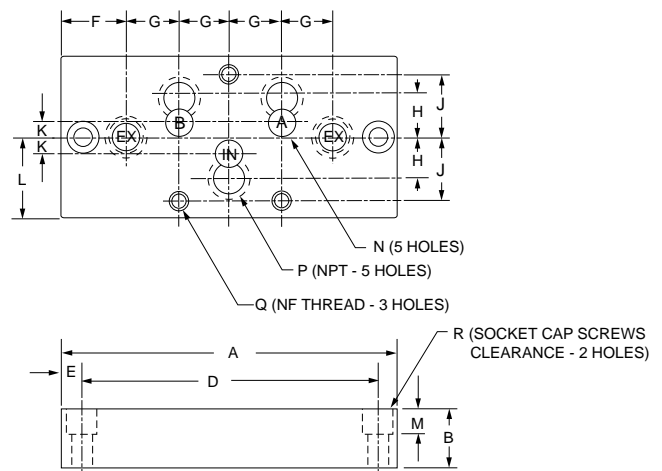

SUB-PLATE PRODUCT NUMBERS *Product numbers shown provide NPT ports. For ports with G thread add Suffix-2B.	Side Ported	M-420-A	M-430-A	M-440-A	M-450-A	M-460-A	M-470-A	M-470-A-12	—						
	Bottom Ported	M-421-A	M-431-A	M-441-A	M-451-A	M-461-A	M-471-A	—	M-471-A-12						
VALVE SIZE	1/8	1/4		3/8		1/2		3/4		1		1 1/4		1 1/4	
	in mm	in mm	in mm	in mm	in mm	in mm	in mm	in mm	in mm	in mm	in mm	in mm	in mm	in mm	
A	4.25 108	4.25 108	6 152	6 152	9.125 232	9.125 232	9.125 232	9.125 232	9.125 232	9.125 232	9.125 232	9.125 232	9.125 232		
B	0.75 19	0.75 19	1.25 32	1.25 32	2 51	2 51	2.5 64	2 51	2 51	2.5 64	2 51	2 51	2 51		
C	2 51	2 51	3 76	3 76	4 102	4 102	4 102	4 102	4 102	4 102	4 102	4 102	4 102		
D	3.75 95	3.75 95	5.375 137	5.375 137	8.25 210	8.25 210	See note below								
E	0.25 6	0.25 6	0.31 7.9	0.31 7.9	0.44 11	0.44 11	0.44 11	0.44 11	0.44 11	0.44 11	0.44 11	0.44 11	0.44 11		
F	0.84 21	0.84 21	1 25	1 25	1.56 40	1.56 40	1.56 40	1.56 40	1.56 40	1.56 40	1.56 40	1.56 40	1.56 40		
G	0.66 17	0.66 17	1 25	1 25	1.5 38	1.5 38	1.5 38	1.5 38	1.5 38	1.5 38	1.5 38	1.5 38	1.5 38		
H	0.375 10	0.375 10	0.625 16	0.625 16	1 25	1 25	1.25 32	—	—	—	—	—	—		
J	0.78 20	0.78 20	1.125 29	1.125 29	1.56 40	1.56 40	See note below								
K	0.19 5	0.19 5	0.31 7.9	0.31 7.9	0.44 11	0.44 11	0.44 11	0.44 11	0.44 11	0.44 11	0.44 11	0.44 11	0.44 11		
L	1 25	1 25	1.5 38	1.5 38	2 51	2 51	2 51	2 51	2 51	2 51	2 51	2 51	2 51		
M	0.5 13	0.5 13	0.75 19	0.75 19	1 25	1 25	—	—	1 25	—	—	1 25	—		
N	0.375 10	0.375 10	.625 16	.625 16	1 25	1 25	1.25 32	1.25 32	1.25 32	1.25 32	1.25 32	1.25 32	1.25 32		
* P	1/8 NPT	1/4 NPT	3/8 NPT	1/2 NPT	3/4 NPT	1 NPT	1 1/4 NPT	1 1/4 NPT	1 1/4 NPT	1 1/4 NPT	1 1/4 NPT	1 1/4 NPT	1 1/4 NPT		
Q	1/4 NF	1/4 NF	5/16 NF	5/16 NF	3/8 NF	3/8 NF	3/8 NF	3/8 NF	3/8 NF	3/8 NF	3/8 NF	3/8 NF	3/8 NF		
R	0.25 6	0.25 6	0.31 7.9	0.31 7.9	0.5 13	0.5 13	0.5 13	0.5 13	0.5 13	0.5 13	0.5 13	0.5 13	0.5 13		

Consult factory for mounting hole and bottom port locations.

VM CO-ORDINATES

2 & 3-STATION FOR FOUR-WAY VALVES

TWO-WAY AND THREE-WAY valves may be intermixed on the same manifold.
 (4 or more valve stations can be provided by joining multiples of the 2 or 3-station)

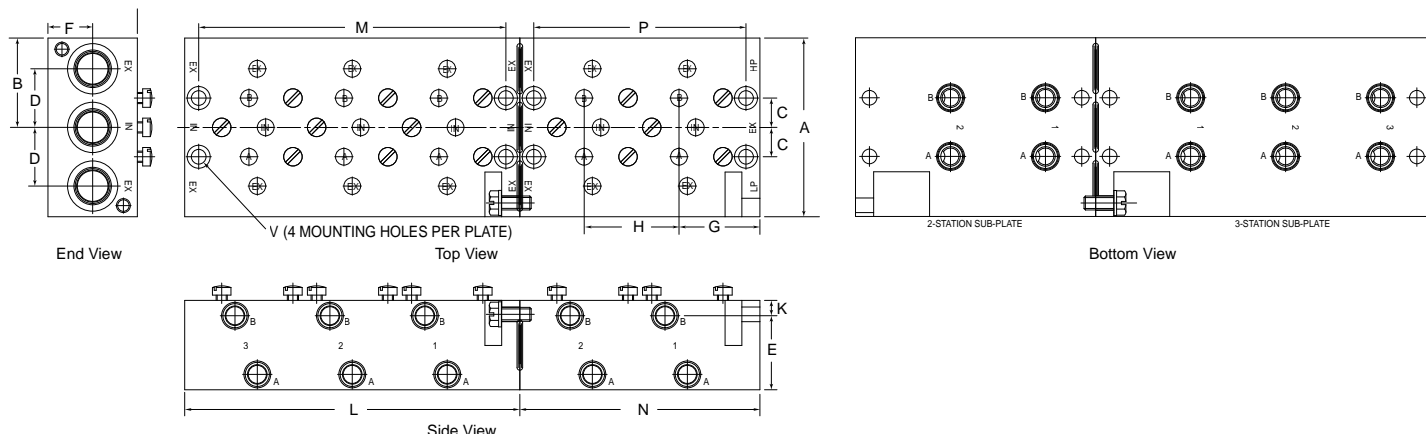

Bleed Control or Pilot Manifold Adapter plates are available. Consult factory.

DIMENSIONS - Inches (mm)

Drawing Key	A	B	C	D	E	F	G	H	K	L	M	N	P	V	W
For 1/4" Valves	4 (102)	2 (51)	0.66 (17)	1.31 (33)	2 (51)	1 (25)	1.63 (41)	1.125 (25.6)	0.34 (9)	7.5 (191)	6.88 (175)	5.38 (137)	4.75 (121)	0.25"	0.5"
For 1/2" Valves	6 (152)	3 (76)	1 (25)	2 (51)	3 (76)	1.5 (38)	2 (51)	3 (76)	0.5 (13)	10 (254)	9.38 (238)	7 (178)	6.38 (162)	0.5"	1"
Key letters A-K refer to sizes common to both 2 and 3-Station Co-Ordinates										3-Station Co-Ordinates only		2-Station Co-Ordinates only		Common Port sizes.	

HOW TO ORDER CO-ORDINATES

Product numbers shown are for Co-Ordinates only. Valves and accessories are ordered separately.

For help in specifying required valves refer to pages 12 and 13.

When Two-Way and/or Three-Way valves are to be mounted on the same manifold, a BLIND PLUG is required for each of the unused exhaust ports and cylinder ports on the mounting face of the Co-Ordinate. These plugs are assembled, but must be ordered separately as follows: VM-BP-43 for 1/4" size valves; VM-BP-45 for 1/2" size.

Valve Size	NPT Co-Ordinate Product No.
1/4"	VM-433-**
1/2"	VM-453-**

** Insert No. of valve mounting stations required. Example: A 7 station Co-Ordinate for 1/2" Valves is VM-453-7 with NPT threads.

ACCESSORIES	Valve Size	
	1/4"	1/2"
Bleed Control Adapter	VM-BC-43	VM-BC-45
Pilot Manifold Adapter	VM-PM-43	VM-PM-45
Bleed Control & Pilot Manifold Adapter	VM-BC-43-30	VM-BC-45-30
†Station Blank	SB-43	SB-45
Exhaust Combiner Adapter	VM-EB-43	VM-EB-45

† Required to block and protect any unused or "future" valve mounting stations.

5

WAY VALVES 5/2 and 5/3

Five-Way Valves are actually dual-pressure Four-Way Valves. Two separate inlets generally are used to control a double acting cylinder so that one pressure is used to direct the work stroke of the cylinder and the other pressure is used to return the cylinder.



NOMINAL PRESSURE RANGE

(Consult pressure rating chart on Page 6 for specific pressure rating of each valve.)

Series "V": partial vacuum to 200 psi (14 bar) pneumatic

Series "T": 0-500 psi (35 bar) hydraulic

ACTUATION

MANUAL, MECHANICAL, PILOT
or SOLENOID-PILOT

BODY TYPES:

All Series "V" & "T" Five-Way Valves are available in the two body types described below. Actuators used with either body type are completely interchangeable.

SIDE-PORTED

The side-ported body provides threaded ports in the body of the valve.



PORT SIZES: 1/8, 1/4, 3/8, 1/2, 3/4, and 1 NPT
1/8, 1/4, 3/8, and 1/2 G

SUB-PLATE MOUNTING

The Sub-plate mounting valve is shown mounted on an individual sub-plate. See page 48 for details on the sub-plate.



PORT SIZES: 1/8, 1/4, 3/8, 1/2, 3/4, 1, 1-1/4 NPT and G

SPECIFICATIONS

Refer to pages 3 through 11 for information concerning:

- Construction
- Seals
- Port Sizes
- Flow
- Pressure Ranges
- Electrical
- Temperature
- Filtration & Lubrication

STANDARD FLOW PATTERNS

TWO INLET, TWO OUTLETS, ONE EXHAUST

Valves must be connected in accordance with the port markings so that the flow is from the inlet port to the outlet port or from outlet port to exhaust. The flow within the valve should never be reversed. Note: When used in a vacuum system, the vacuum pump is connected to the outlet port

TWO POSITION 5/2

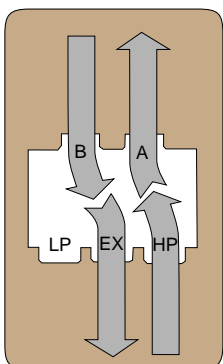

HP inlet open to cylinder port A;
cylinder port B open to exhaust

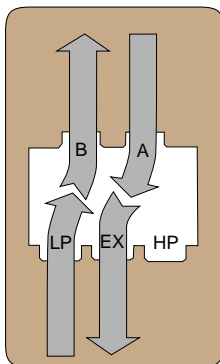

LP inlet open to cylinder port B;
cylinder port A open to exhaust

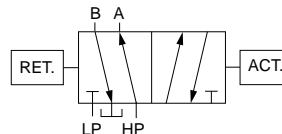

3 POSITION 5/3 Diagrams below show center position only. Offset positions are same as shown above for 2-position types. To indicate particular center pattern required, substitute number shown within corresponding diagram for fourth digit of product number.

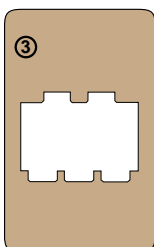

All ports blocked

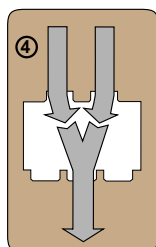

Cylinder ports open to exhaust.

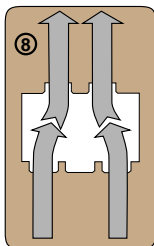

Inlet open to both
cylinder ports.

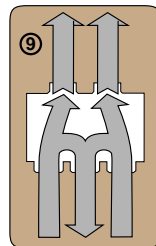

All ports open.

5

WAY-MOUNTING DIMENSIONS

Port hole locations and mounting hole size and locations shown in the individual Body Detail below apply to all Five-Way valves, regardless of type of actuation. The overall dimensions shown for each type of valve actuation apply whether for side ported or sub-plate mounting type.

BODY DETAIL

SIDEPORTED

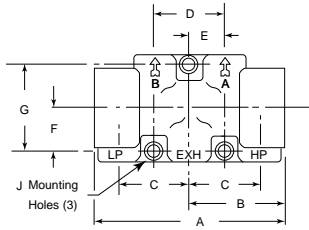

SUBPLATE MOUNTING

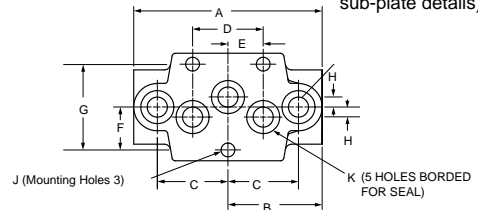

(See page 48 for sub-plate details)

SIZE	A		B		C		D		E		F		G		H		J Ø	K Ø		
	in	mm	in	mm	in	mm	in	mm	in	mm	in	mm	in	mm	in	mm	in	mm		
1/8-1/4 SIDE PORTED or SUB-PLATE MOUNTING	3.5	89	1.72	44	1.31	33	1.31	33	0.66	17	0.8	20	1.59	40	0.19	5	0.25	6	0.38	9.7
3/8-1/2 SIDE PORTED or SUB-PLATE MOUNTING	5.75	146	2.88	73	2	51	2	51	1	25	1.13	29	2.25	57	0.31	7.9	0.32	8	0.56	14
3/4-1 SIDE PORTED or SUB-PLATE MOUNTING	8.5	216	4.25	108	3	76	3	76	1.5	38	1.56	40	3.13	79	0.44	11.2	0.39	10	1	25
1-1/4 [†] SIDE PORTED or SUB-PLATE MOUNTING	8.5	216	4.25	108	3	76	3	76	1.5	38	1.56	40	3.13	79	0.44	11.2	0.39	10	1.25	32

HAND ACTUATED VALVES

OFFSET LEVER TYPE

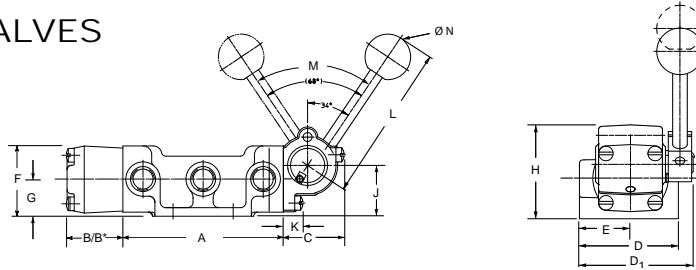

SIZE	A		B		B*		C		D1		D		E		F		G		H		J		K		L	M	N Ø		
	in	mm	in	mm	in	mm	in	mm	in	mm	in	mm	in	mm	in	mm	in	mm	in	mm	in	mm	in	mm	°	in	mm		
1/8-1/4	3.5	89	1.22	31	1.84	47	1.34	34	2.31	59	2	51	1	25	1.5	38	0.81	21	2	51	1.13	29	0.53	13	3	76	68	1	25
3/8-1/2	5.75	146	1.22	31	1.84	47	1.34	34	2.75	70	2.75	70	1.38	35	1.69	43	0.88	22	2.06	52	1.19	30	0.53	13	3	76	68	1	25
3/4-1	8.5	216	2.06	52	3.22	82	2	51	3.75	95	3.75	95	1.88	48	2.44	62	1.25	32	2.97	75	1.72	44	0.81	21	5	127	62	1.25	32

*Dimensions for Spring-Centering Valves

CENTERLINE LEVER TYPE

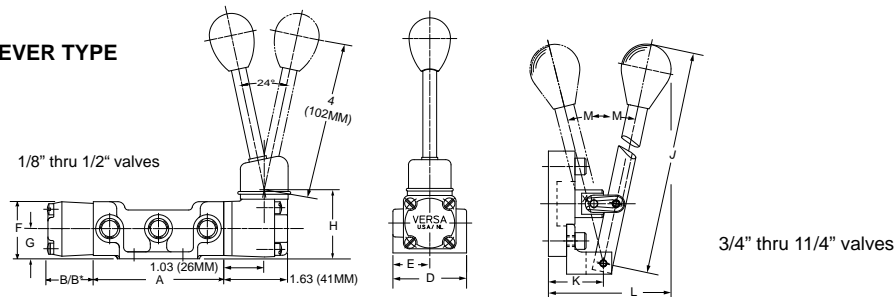

SIZE	A		B		B*		D		E		F		G		H		J	K	L	M			
	in	mm	in	mm	in	mm	in	mm	in	mm	in	mm	in	mm	in	mm	in	mm	in	mm	°		
1/8-1/4	3.5	89	1.22	31	1.84	47	2	51	1	25	1.5	38	0.81	21	1.81	46	—	—	—	—	—	—	
3/8-1/2	5.75	146	1.22	31	1.84	47	2.75	70	1.38	35	1.69	43	0.88	22	1.88	48	—	—	—	—	—	—	
3/4-1	8.5	216	2.06	52	3.22	82	3.75	95	1.88	48	2.44	62	1.25	32	—	—	8	203	1.31	33	3.75	95	13
1-1/4 [†]	8.5	216	2.06	52	2.38	61	3.75	95	1.88	48	2.44	62	1.25	32	—	—	8.88	225	2.31	59	5.69	145	18.5

*Dimensions for Spring-Centering Valves

[†]1 1/4" size valve has internal capacity of 1 1/4" (32mm) diameter. Sideported valves have 1" NPT ports; subplate for subplate mounting style has 1 1/4" NPT ports.

BUTTON ACTUATED VALVES

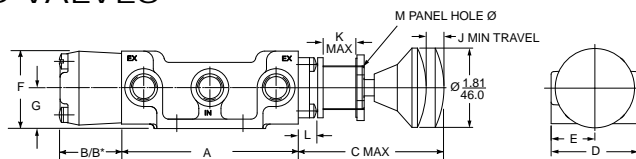

SIZE	A	B	B*	C	D	E	F	G	J	K	L	M
	in mm	in mm	in mm	in mm	in mm	in mm	in mm	in mm	in mm	in mm	in mm	in mm
1/8-1/4	3.5 89	1.22 31	1.84 47	3.25 83	2 51	1 25	1.5 38	0.81 21	0.38 9.7	0.75 19	0.53 13	1 25
3/8-1/2	5.75 146	1.22 31	1.84 47	3.25 83	2.75 70	1.38 35	1.69 43	0.88 22	0.38 9.7	0.75 19	0.53 13	1 25
3/4-1 1/4	8.5 216	2.06 52	— —	4.34 110	3.75 95	1.88 48	2.44 62	1.25 32	0.59 15	1.38 35	0.69 18	1.38 35

*Dimensions for Spring-Centering Valves

FOOT ACTUATED VALVES/PEDAL and TREADLE

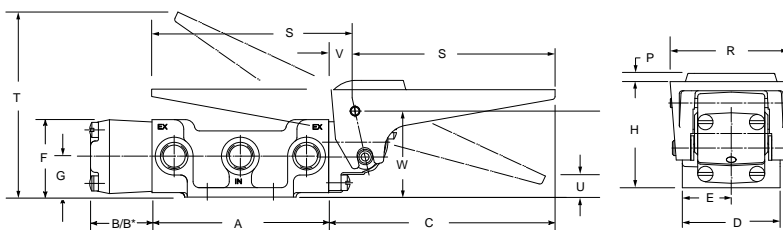

SIZE	A	B	B*	C	D	E	F	G	H	P	R	S	T	U	V	W
	in mm	in mm	in mm	in mm	in mm	in mm	in mm	in mm	in mm	in mm	in mm	in mm	in mm	in mm	in mm	in mm
1/8-1/4	3.5 89	1.22 31	1.84 47	4.53 115	2 51	1 25	1.5 38	0.81 21	2.13 54	0.19 5	2.5 64	4 102	3.88 99	0.38 9.7	0.5 13	1.72 44
3/8-1/2	5.75 146	1.22 31	1.84 47	4.53 115	2.75 70	1.38 35	1.69 43	0.88 22	2.19 56	0.19 5	2.5 64	4 102	3.94 100	0.44 11	0.5 13	1.18 46
3/4-1	8.5 216	2.06 52	3.22 82	4.81 122	3.75 95	1.88 48	2.44 62	1.25 32	3.19 81	.25 6	3.63 92	4 102	5 127	1 25	0.63 16	2.69 68

*Dimensions for Spring-Centering Valves

CAM ACTUATED VALVES

NORMAL DUTY

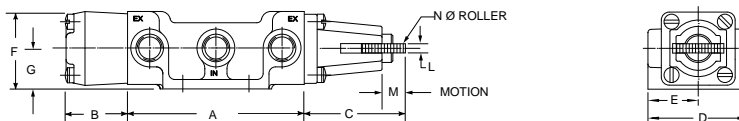

SIZE	A	B	C	D	E	F	G	L	M	N
	in mm	in mm	in mm	in mm	in mm	in mm	in mm	in mm	in mm	in mm
1/8-1/4	3.5 89	1.22 31	2 51	2 51	1 25	1.5 38	0.81 21	0.19 5	0.38 9.7	0.88 22
3/8-1/2	5.75 146	1.22 31	2 51	2.75 70	1.38 35	1.69 43	0.88 22	0.19 5	0.38 9.7	0.88 22
3/4-1	8.5 216	2.06 52	3.22 82	3.75 95	1.88 48	2.44 62	1.25 32	0.31 7.9	0.63 16	1.25 32

HEAVY DUTY

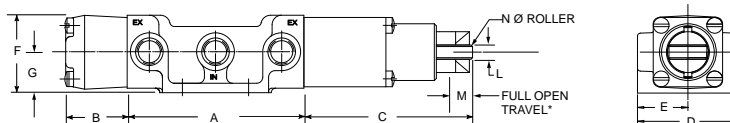

SIZE	A	B	C	D	E	F	G	L	M	N
	in mm	in mm	in mm	in mm	in mm	in mm	in mm	in mm	in mm	in mm
1/8-1/4	3.5 89	1.22 31	3.34 85	2 51	1 25	1.5 38	0.81 21	0.28 7	.4 10	0.75 19
3/8-1/2	5.75 146	1.22 31	3.34 85	2.75 70	1.38 35	1.69 43	0.88 22	0.28 7	.4 10	0.75 19

*Maximum Permissible Over-Travel — 1/4" (6.4mm)

Refer to page 44 under Body Detail, for port and mounting hole locations for all valves shown above.

5

WAY-MOUNTING DIMENSIONS

PILOT ACTUATED VALVES SINGLE PILOT

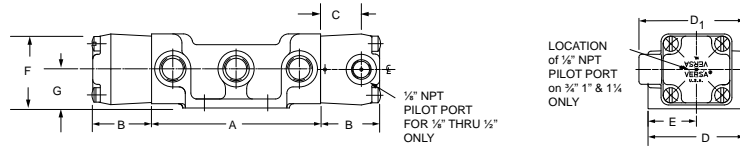

DOUBLE PILOT

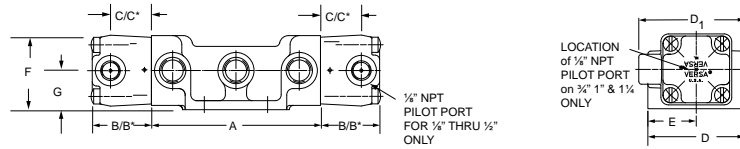

SIZE	A		B		B*		C		C*		D1		D		E		F		G	
	in	mm	in	mm	in	mm	in	mm	in	mm	in	mm	in	mm	in	mm	in	mm	in	mm
1/8-1/4	3.5	89	1.22	31	2.13	54	0.84	21	1.73	44	2.19	56	2	51	1	25	1.5	38	0.81	21
3/8-1/2	5.75	146	1.22	31	2.13	54	0.84	21	1.73	44	2.69	68	2.75	70	1.38	35	1.69	43	0.88	22
3/4-1-1/4†	8.5	216	2.06	52	3.53	90	—	—	—	—	—	—	3.75	95	1.88	48	2.44	62	1.25	32

*Dimensions for Spring-Centering Valves

DIAPHRAGM ACTUATED VALVES

SINGLE DIAPHRAGM

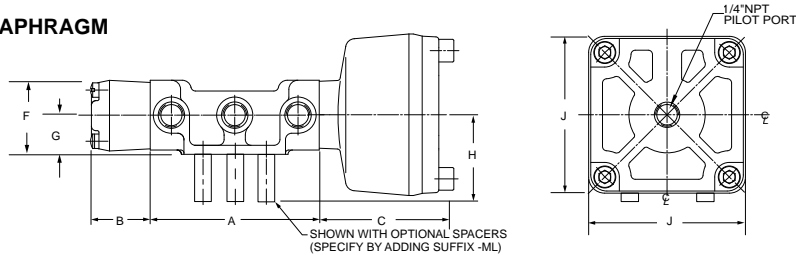

DOUBLE DIAPHRAGM

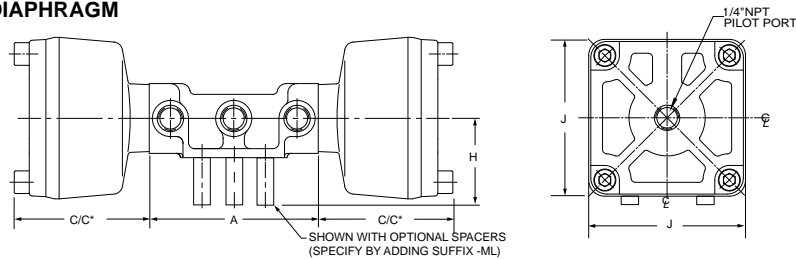

SIZE	A		B		C		C*		F		G		H		J	
	in	mm	in	mm	in	mm	in	mm	in	mm	in	mm	in	mm	in	mm
1/8-1/4	3.5	89	1.22	31	2.75	70	2.84	72	1.5	38	0.81	21	1.69	43	3.34	85
3/8-1/2	5.75	146	1.22	31	2.75	70	2.84	72	1.69	43	0.88	22	1.75	45	3.34	85
3/4-1	8.5	216	2.06	52	2.97	75	3.69	94	2.44	62	1.25	32	1.75	45	3.25	83
1-1/4†	8.5	216	2.06	52	3.22	82	3.94	100	2.44	62	1.25	32	1.75	45	3.25	83

*Dimensions for Spring-Centering Valves

Refer to page 44 under Body Detail, for port and mounting hole locations for all valves shown above.

1 1/4" size valve has internal capacity of 1 1/4" (32mm) diameter. Sideported valves have 1" NPT ports; subplate for subplate mounting style has 1 1/4" NPT ports

SOLENOID ACTUATED VALVES/INLINE (Non Hazardous Service)

SINGLE SOLENOID

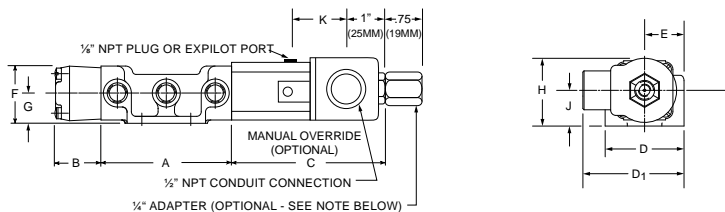

DOUBLE SOLENOID

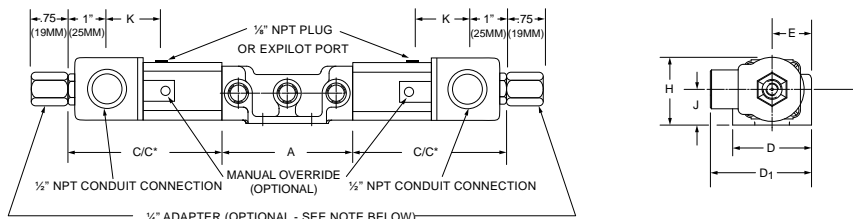

SIZE	A	B	C	C*	D1	D	E	F	G	H	J	K												
	in	mm	in	mm	in	mm	in	mm	in	mm	in	mm												
1/8-1/4	3.5	89	1.22	31	3.94	100	4.84	123	2.56	65	2	51	1	25	1.5	38	0.81	21	1.72	44	0.91	23	1.63	41
3/8-1/2	5.75	146	1.22	31	3.94	100	4.84	123	2.94	75	2.75	70	1.38	35	1.69	43	0.88	22	1.78	45	0.97	25	1.63	41
3/4-1-1 1/4†	8.5	216	2.06	52	4.5	114	5.97	152	3.44	87	3.75	95	1.88	48	2.44	62	1.25	32	2.44	62	1.25	32	1.41	36

*Dimensions for Spring-Centering Valves

NOTE: Adapter is supplied when specified, by adding suffix "-H" to product number

SOLENOID ACTUATED VALVES/UPRIGHT (Non Hazardous Service Valves. For hazardous service valves see Page 9 - 11.)

SINGLE SOLENOID

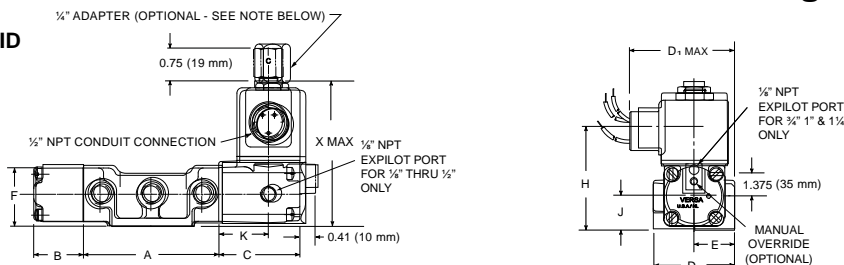

DOUBLE SOLENOID

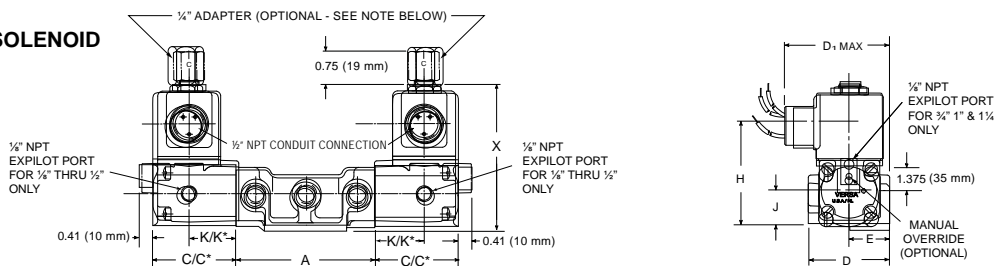

SIZE	A	B	C	C*	D1	D	E	F	H	J	K	K*	X													
	in	mm	in	mm	in	mm	in	mm	in	mm	in	mm	in	mm												
1/8-1/4	3.5	89	1.22	31	2.09	53	3	76	2.5	64	2	51	1	25	1.5	38	2.59	66	0.81	21	1.28	33	2.19	56	3.81	97
3/8-1/2	5.75	146	1.22	31	2.09	53	3	76	2.88	73	2.75	70	1.38	35	1.69	43	2.66	68	0.88	22	1.28	33	2.19	56	3.88	99
3/4-1-1 1/4†	8.5	216	2.06	52	2	51	3.47	88	3.44	87	3.75	95	1.88	48	2.44	62	3.91	99	1.25	32	1	25	2.5	64	5.16	131

*Dimensions for Spring-Centering Valves

NOTE: Adapter is supplied when specified, by adding suffix "-H" to product number

Refer to page 44 under Body Detail, for port and mounting hole locations for all valves shown above.
 †1 1/4" size valve has internal capacity of 1 1/4" (32mm) diameter. Sideported valves have 1" NPT ports; subplate for subplate mounting style has 1 1/4" NPT ports.

SUB-PLATES (SINGLE STATION TYPE)

Will mount series "V" or "T" sub-plate type valves. Multiple valve station manifolds (VM Co-Ordinates) for the mounting of several valves are also available. See page 49. For sub-plates to mount plug-in solenoids, consult factory.

FOR FIVE-WAY VALVES

SIDE-PORTED

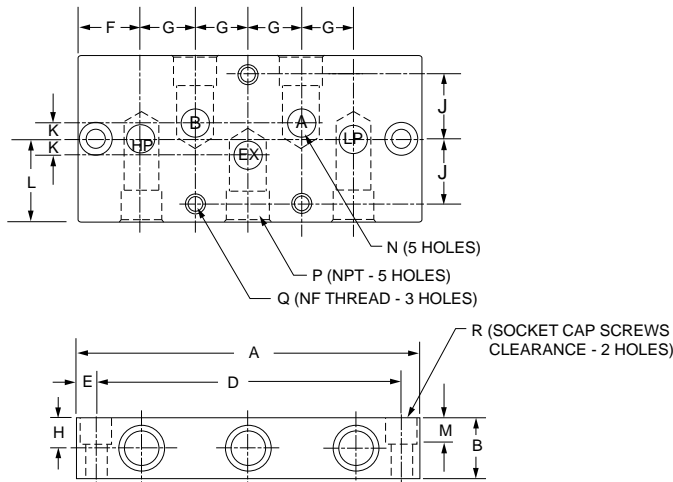

BOTTOM PORTED

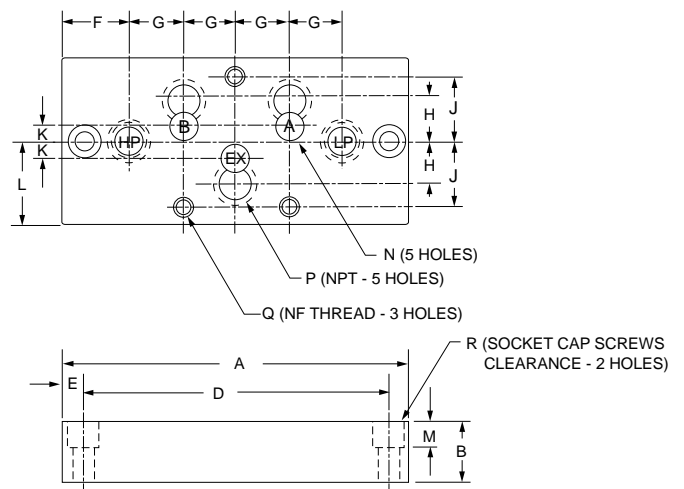

SUB-PLATE PRODUCT NUMBERS *Product numbers shown provide NPT ports. For ports with G thread add Suffix-2B.	Side Ported		M-420-A		M-430-A		M-440-A		M-450-A		M-460-A		M-470-A		M-470-A-12		—	
	Bottom Ported		M-421-A		M-431-A		M-441-A		M-451-A		M-461-A		M-471-A		—		M-471-A-12	
VALVE SIZE	1/8		1/4		3/8		1/2		3/4		1		1 1/4		1 1/4			
	in	mm	in	mm	in	mm	in	mm	in	mm	in	mm	in	mm	in	mm	in	mm
A	4.25	108	4.25	108	6	152	6	152	9.125	232	9.125	232	9.125	232	9.125	232		
B	0.75	19	0.75	19	1.25	32	1.25	32	2	51	2	51	2.5	64	2	51		
C	2	51	2	51	3	76	3	76	4	102	4	102	4	102	4	102		
D	3.75	95	3.75	95	5.375	137	5.375	137	8.25	210	8.25	210	See note below					
E	0.25	6	0.25	6	0.31	7.9	0.31	7.9	0.44	11	0.44	11	0.44	11	0.44	11		
F	0.84	21	0.84	21	1	25	1	25	1.56	40	1.56	40	1.56	40	1.56	40		
G	0.66	17	0.66	17	1	25	1	25	1.5	38	1.5	38	1.5	38	1.5	38		
H	0.375	10	0.375	10	0.625	16	0.625	16	1	25	1	25	1.25	32	—	—		
J	0.78	20	0.78	20	1.125	29	1.125	29	1.56	40	1.56	40	See note below					
K	0.19	5	0.19	5	0.31	7.9	0.31	7.9	0.44	11	0.44	11	0.44	11	0.44	11		
L	1	25	1	25	1.5	38	1.5	38	2	51	2	51	2	51	2	51		
M	0.5	13	0.5	13	0.75	19	0.75	19	1	25	1	25	—	—	1	25		
N	0.375	10	0.375	10	0.625	16	0.625	16	1	25	1	25	1.25	32	1.25	32		
*P	1/8 NPT		1/4 NPT		3/8 NPT		1/2 NPT		3/4 NPT		1 NPT		1 1/4 NPT		1 1/4 NPT			
Q	1/4 NF		1 4 NF		5/16 NF		5/16 NF		3/8 NF		3/8 NF		3/8 NF		3/8 NF			
R	0.25	6	0.25	6	0.31	7.9	0.31	7.9	0.5	13	0.5	13	0.5	13	0.5	13		

Consult factory for mounting hole and bottom port locations.

VM CO-ORDINATES

2 & 3-STATION FOR FIVE-WAY VALVES

(4 or more valve stations can be provided by joining multiples of the 2 or 3-station)

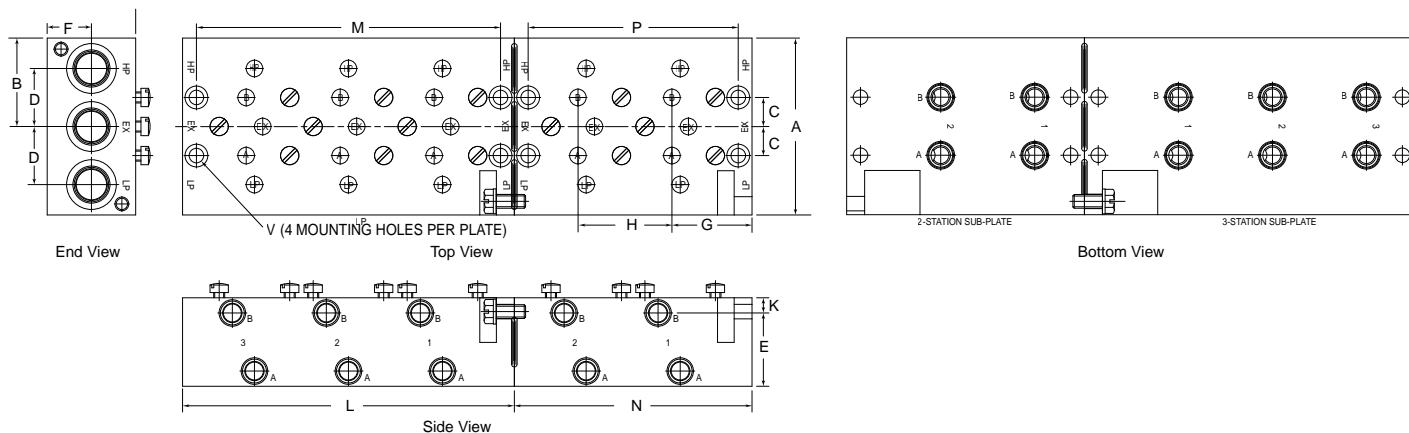

Pilot Manifold Adapter plates are available for mounting pilot valves with manifold mounted pilot ports. Consult factory.

DIMENSIONS - Inches (mm)

Drawing Key	A	B	C	D	E	F	G	H	J	K	L	M	N	P	V	W
For 1/4" Valves	4 (102)	2 (51)	0.66 (17)	1.31 (33)	2 (51)	1 (25)	1.63 (41)	2.125 (54)	0.5 (13)	0.34 (9)	7.5 (191)	6.88 (175)	5.38 (137)	4.75 (121)	0.25"	0.5"
For 1/2" Valves	6 (152)	3 (76)	1 (25)	2 (51)	3 (76)	1.5 (38)	2 (51)	3 (76)	0.75 (19)	0.5 (13)	10 (254)	9.38 (238)	7 (178)	6.38 (162)	0.5"	1"
Key letters A-K refer to sizes common to both 2 and 3-Station Co-Ordinates											3-Station Co-Ordinates only		2-Station Co-Ordinates only		Common Port sizes.	

HOW TO ORDER CO-ORDINATES

Product numbers shown are for Co-Ordinates only. Valves and accessories are ordered separately.
For help in specifying required valves refer to pages 12 and 13.

Valve Size	NPT Co-Ordinate Product No.
1/4"	VM-533-**
1/2"	VM-553-**

ACCESSORIES	Valve Size	
	1/4"	1/2"
Pilot Manifold Adapter	VM-PM-43	VM-PM-45
†Station Blank	SB-43	SB-45

** Insert No. of valve mounting stations required. Example: A 7 station Co-Ordinate for 1/4" Valves is VM-553-7 with NPT threads.

† Required to block and protect any unused or "future" valve mounting stations.

PARTS LIST/BODY ASSEMBLY

The same Body Assembly is used for both normally open and normally closed valves. The determinant for normally closed and normally open is the location of the actuator in respect to the right and left end of the Body Assembly (when facing the inlet port). If the actuator is to the left the valve is normally open and if to the right the valve is normally closed.

(TWO-WAY VALVES)

Body Assembly Numbers are for "V" Series valves. For "T" Series, place the letter "T" in front of no. shown: i.e TSA-2201-63.

1/8" AND 1/4" PORT SIZES

1/8" BODY ASSEMBLY

- SA-2201-63
(Side Ports — EXPilot)
- SA-2221-63
(Side Ports — INPilot)
- SA-2311-63
(Sub-plate Mtg. — EXPilot)
- SA-2331-63
(Sub-plate Mtg. — INPilot)

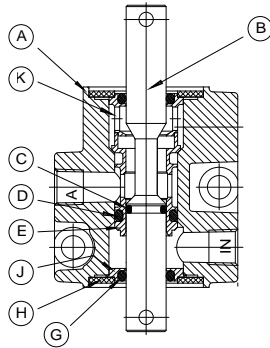

Approx. Weight = 1.11 lbs.
(0.50 kg)

LEGEND	PART NAME	PART NUMBER		UNITS REQUIRED
		1/8"	1/4"	
A	Body (Side Ports — EXPilot)	2201-01	2301-01	One
	Body (Side Ports — INPilot)	2221-01	2321-01	One
	Body (Sub-plate Mtg. — EXPilot)*	2311-01*		One
	Body (Sub-plate Mtg. — INPilot)*	2331-01*		One
B	Plunger	3301-02		One
C	"O" Ring	P-1100-06†		One
D	"O" Ring	P-1000-10		One
E	Bushing	4302-04		One
G	"O" Ring	P-1000-09		Two
H	Gasket	4302-44		Two
J	Flange	4302-42		One
K	Retainer	4302-43		One

*Two P-1100-09 "O" Rings required for port gaskets on Sub-plate Mounting.
† Part No. for "T" Series changes to T-1000-06

1/4" BODY ASSEMBLY

- SA-2301-63
(Side Ports — EXPilot)
- SA-2321-63
(Side Ports — INPilot)
- SA-2311-63
(Sub-plate Mtg. — EXPilot)
- SA-2331-63
(Sub-plate Mtg. — INPilot)

3/8" AND 1/2" PORT SIZES

3/8" BODY ASSEMBLY

- SA-2401-73
(Side Ports — EXPilot)
- SA-2421-73
(Side Ports — INPilot)
- δ SA-2511-73
(Sub-plate Mtg. — EXPilot)
- δ SA-2531-73
(Sub-plate Mtg. — INPilot)

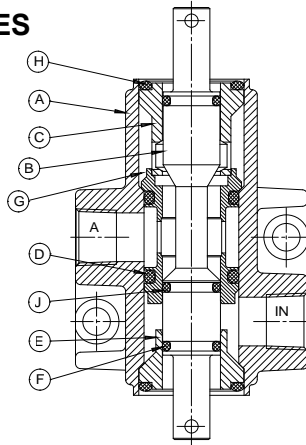

Approx. Weight = 2.77 lbs.
(1.26 kg)

LEGEND	PART NAME	PART NUMBER		UNITS REQUIRED
		3/8"	1/2"	
A	Body (Side Ports — EXPilot)	2401-01	2501-01	One
	Body (Side Ports — INPilot)	2421-01	2521-01	One
	δ Body (Sub-plate Mtg. — EXPilot)*	2511-01*		One
	δ Body (Sub-plate Mtg. — INPilot)*	2531-01*		One
B	Plunger	3501-02		One
C	Retainer	4502-43		One
D	"O" Ring	P-1000-17		One
E	Bushing	4502-04		One
F	"O" Ring	P-1000-10		Two
G	Bearing	4502-33		One
H	"O" Ring	P-1000-19		Two
J	"O" Ring	P-1100-10†		One

* Two P-1100-13 "O" Rings required for port gaskets on Sub-plate Mounting.
† Part No. for "T" Series changes to T-1000-10
δ Subplate mounting style bodies & body assemblies utilized with Treadle Actuators require addition of Suffix -3470 to part, subassembly and complete product number.

1/2" BODY ASSEMBLY

- SA-2501-73
(Side Ports — EXPilot)
- SA-2521-73
(Side Ports — INPilot)
- δ SA-2511-73
(Sub-plate Mtg. — EXPilot)
- δ SA-2531-73
(Sub-plate Mtg. — INPilot)

3/4", 1" AND 1 1/4" PORT SIZES

3/4" BODY ASSEMBLY

- SA-2601-63
(Side Ports — EXPilot)
- SA-2621-63
(Side Ports — INPilot)
- SA-2711-63
(Sub-plate Mtg. — EXPilot)
- SA-2731-63
(Sub-plate Mtg. — INPilot)

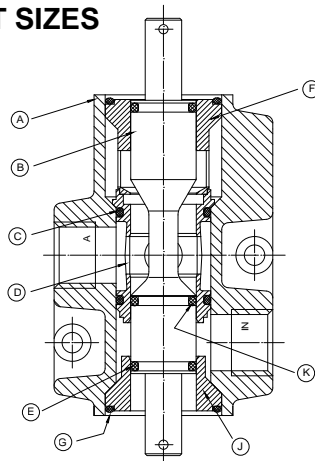

Approx. Weight = 7.35 lbs.
(3.33 kg)

(For 1 1/4" Valve Body Assemblies, add suffix detail "-12" to corresponding Sub-assembly No. shown for 1" valve.)

LEGEND	PART NAME	PART NUMBER			UNITS REQUIRED
		3/4"	1"	1 1/4"	
A	Body (Side Ports — EXPilot)	2601-01	2701-01	2701-01-12	One
	Body (Side Ports — INPilot)	2621-01	2721-01	2721-01-12	One
	Body (Sub-plate Mtg. — EXPilot)*	2711-01*		2711-01-12*	One
	Body (Sub-plate Mtg. — INPilot)*	2731-01*		2731-01-12*	One
B	Plunger	3701-02††		3701-02-12††	One
C	"O" Ring	P-1000-25		P-1000-27	One
D	Bushing	4702-04		4702-04-12	One
E	"O" Ring	P-1000-17		P-1000-24	Two
F	Retainer	4702-43		4702-43-12	One
G	"O" Ring	P-1004-02		P-1004-02	Two
J	Bearing	4702-33		4702-33-12	One
K	"O" Ring	P-1100-17†		P-1100-20	One

* Two P-1100-21 "O" Rings required for port gaskets on Sub-plate Mounting for 1" valve and two P-1000-23 "O" Rings for 1 1/4" valve.
† Part No. for "T" Series changes to T-1000-17
†† For use with Hand Lever Cap (L) add suffix -28B for 3/4" or 1" size, Suffix -12A for 1 1/4" size.

PARTS LIST/BODY ASSEMBLY

The same Body Assembly is used for both normally open and normally closed valves. The determinant for normally closed and normally open is the location of the actuator in respect to the right and left end of the Body Assembly (when facing the inlet port). If the actuator is to the left the valve is normally open and if to the right the valve is normally closed.

Body Assembly Numbers are for "V" Series valves. For "T" Series, place the letter "T" in front of no. shown: i.e TSA-3201-63.

(THREE-WAY VALVES)

1/8" AND 1/4" PORT SIZES

1/8" BODY ASSEMBLY**
(2 position)

- SA-3201-62
(Side Ports — EXPilot)
- SA-3221-62
(Side Ports — INPilot)
- SA-3311-62
(Sub-plate Mtg. — EXPilot)
- SA-3331-62
(Sub-plate Mtg. — INPilot)

1/4" BODY ASSEMBLY**
(2 position)

- SA-3301-62
(Side Ports — EXPilot)
- SA-3321-62
(Side Ports — INPilot)
- SA-3311-62
(Sub-plate Mtg. — EXPilot)
- SA-3331-62
(Sub-plate Mtg. — INPilot)

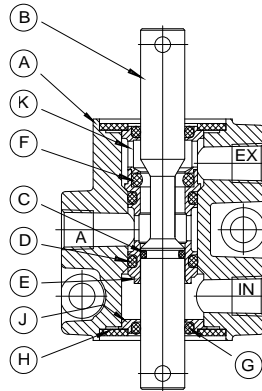

Approx. Weight = 1.12 lbs.
(0.51 kg)

LEGEND	PART NAME	PART NUMBER		UNITS REQUIRED
		1/8"	1/4"	
A	Body (Side Ports — EXPilot)	3201-01	3301-01	One
	Body (Side Ports — INPilot)	3221-01	3321-01	One
	Body (Sub-plate Mtg. — EXPilot)*	3311-01*		One
	Body (Sub-plate Mtg. — INPilot)*	3331-01*		One
B	Plunger	3301-02		One
C	"O" Ring	P-1100-06†		One
D	"O" Ring	P-1000-10		Two
E	Bushing	4302-04		One
F	"O" Ring	P-1000-09††		One
G	"O" Ring	P-1000-09		Two
H	Gasket	4302-44		Two
J	Flange	4302-42		One
K	Retainer	4302-43		One

*Three P-1100-09 "O" Rings required for port gaskets on Sub-plate Mounting.

† Part No. for "T" Series changes to T-1000-06

†† Part No. for "T" Series changes to T-1000-09

3/8" AND 1/2" PORT SIZES

3/8" BODY ASSEMBLY**
(2 position)

- SA-3401-72
(Side Ports — EXPilot)
- SA-3421-72
(Side Ports — INPilot)
- δ SA-3511-72
(Sub-plate Mtg. — EXPilot)
- δ SA-3531-72
(Sub-plate Mtg. — INPilot)

1/2" BODY ASSEMBLY**
(2 position)

- SA-3501-72
(Side Ports — EXPilot)
- SA-3521-72
(Side Ports — INPilot)
- δ SA-3511-72
(Sub-plate Mtg. — EXPilot)
- δ SA-3531-72
(Sub-plate Mtg. — INPilot)

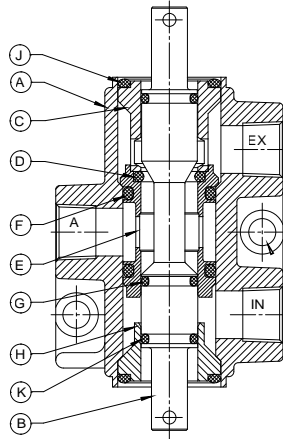

Approx. Weight = 2.93 lbs.
(1.33 kg)

LEGEND	PART NAME	PART NUMBER		UNITS REQUIRED
		3/8"	1/2"	
A	Body (Side Ports — EXPilot)	3401-01	3501-01	One
	Body (Side Ports — INPilot)	3421-01	3521-01	One
	δ Body (Sub-plate Mtg. — EXPilot)*	3511-01*		One
	δ Body (Sub-plate Mtg. — INPilot)*	3531-01*		One
B	Plunger	3501-02		One
C	Retainer	4502-43		One
D	"O" Ring	P-1100-13††		One
E	Bushing	4502-04		One
F	"O" Ring	P-1000-17		Two
G	"O" Ring	P-1100-10†		One
H	Bearing	4502-33		One
J	"O" Ring	P-1000-19		Two
K	"O" Ring	P-1000-10		Two

* Three P-1100-13 "O" Rings required for port gaskets on Sub-plate Mounting.

† Part No. for "T" Series changes to T-1000-10

†† Part No. for "T" Series changes to T-1000-13

δ Subplate mounting style bodies & body assemblies utilized with Treadle Actuators require addition of Suffix -3470 to part, subassembly and complete product number.

3/4", 1" AND 1 1/4" PORT SIZES

3/4" BODY ASSEMBLY**
(2 position)

- SA-3601-62
(Side Ports — EXPilot)
- SA-3621-62
(Side Ports — INPilot)
- SA-3711-62
(Sub-plate Mtg. — EXPilot)
- SA-3731-62
(Sub-plate Mtg. — INPilot)

1" BODY ASSEMBLY**
(2 position)

- SA-3701-62
(Side Ports — EXPilot)
- SA-3721-62
(Side Ports — INPilot)
- SA-3711-62
(Sub-plate Mtg. — EXPilot)
- SA-3731-62
(Sub-plate Mtg. — INPilot)

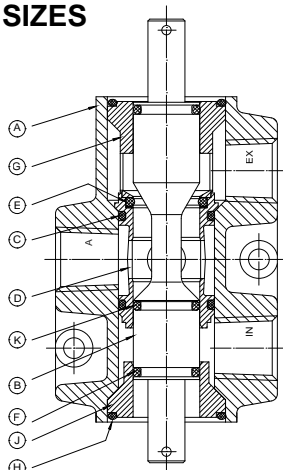

Approx. Weight = 7.65 lbs.
(3.47 kg)

(For 1 1/4" Valve Body Assemblies, add suffix detail "-12" to corresponding Sub-assembly No. shown for 1" valve.)

LEGEND	PART NAME	PART NUMBER			UNITS REQUIRED
		3/4"	1"	1 1/4"	
A	Body (Side Ports — EXPilot)	3601-01	3701-01	3701-01-12	One
	Body (Side Ports — INPilot)	3621-01	3721-01	3721-01-12	One
	Body (Sub-plate Mtg. — EXPilot)*	3711-01*		3711-01-12*	One
	Body (Sub-plate Mtg. — INPilot)*	3731-01*		3731-01-12*	One
B	Plunger	3701-02††		3701-02-12††	One
C	"O" Ring	P-1000-25			Two
D	Bushing	4702-04		4702-04-12	One
E	"O" Ring	P-1100-21†		P-1100-24	One
F	"O" Ring	P-1000-17		P-1000-24	Two
G	Retainer	4702-43		4702-43-12	One
H	"O" Ring	P-1004-02		P-1004-02	Two
J	Bearing	4702-33		4702-33-12	One
K	"O" Ring	P-1100-17†		P-1100-20	One

* Three P-1100-21 "O" Rings required for port gaskets on Sub-plate Mounting for 1" valve and three P-1000-23 "O" Rings for 1 1/4" valve.

† Part No. for "T" Series changes to T-1000-17 and T-1000-21

†† For use with Hand Lever Cap (L) add suffix -28B for 3/4" or 1" size, Suffix -12A for 1 1/4" size.

** For 3-position Body Assemblies with all ports blocked in neutral or center position, the only part that changes is the plunger. To indicate the 3-position plunger or Body Assembly, substitute the number "3" for the fourth digit of the part number shown. For example: 3503-02 is the 3-position plunger; SA-3503-72 is the 3-position Body Assembly.

PARTS LIST/BODY ASSEMBLY

(TWO-INLET VALVES)

Body Assembly Numbers are for "V" Series valves. For "T" Series, place the letter "T" in front of no. shown: i.e TSA-8202-62.

1/8" AND 1/4" PORT SIZES

1/8" BODY ASSEMBLY** (2 position)

- SA-8202-62
(Side Ports — EXPilot)
- SA-8222-62
(Side Ports — INPilot)
- SA-8312-62
(Sub-plate Mtg. — EXPilot)
- SA-8332-62
(Sub-plate Mtg. — INPilot)

1/4" BODY ASSEMBLY** (2 position)

- SA-8302-62
(Side Ports — EXPilot)
- SA-8322-62
(Side Ports — INPilot)
- SA-8312-62
(Sub-plate Mtg. — EXPilot)
- SA-8332-62
(Sub-plate Mtg. — INPilot)

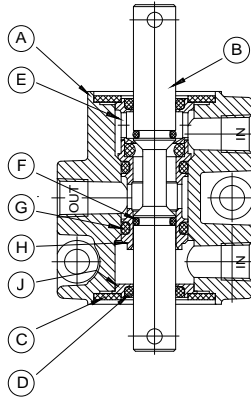

Approx. Weight = 1.12 lbs.
(0.51 kg)

LEGEND	PART NAME	PART NUMBER		UNITS REQUIRED
		1/8"	1/4"	
A	Body (Side Ports — EXPilot)	8201-01	8301-01	One
	Body (Side Ports — INPilot)	8221-01	8321-01	One
	Body (Sub-plate Mtg. — EXPilot)*	8311-01*		One
	Body (Sub-plate Mtg. — INPilot)*	8331-01*		One
B	Plunger	8302-02		One
C	Gasket	4302-44		Two
D	"O" Ring	P-1000-09		Two
E	Retainer	5302-43		One
F	"O" Ring	P-1100-06†		Two
G	"O" Ring	P-1000-10		Two
H	Bushing	8301-04		One
J	Flange	4302-42		One

* Two P-1100-09 "O" Rings required for port gaskets on Sub-plate Mounting.
† Part No. for "T" Series changes to T-1000-06

3/8" AND 1/2" PORT SIZES

3/8" BODY ASSEMBLY** (2 position)

- SA-8402-72
(Side Ports — EXPilot)
- SA-8422-72
(Side Ports — INPilot)
- δ SA-8512-72
(Sub-plate Mtg. — EXPilot)
- δ SA-8532-72
(Sub-plate Mtg. — INPilot)

1/2" BODY ASSEMBLY** (2 position)

- SA-8502-72
(Side Ports — EXPilot)
- SA-8522-72
(Side Ports — INPilot)
- δ SA-8512-72
(Sub-plate Mtg. — EXPilot)
- δ SA-8532-72
(Sub-plate Mtg. — INPilot)

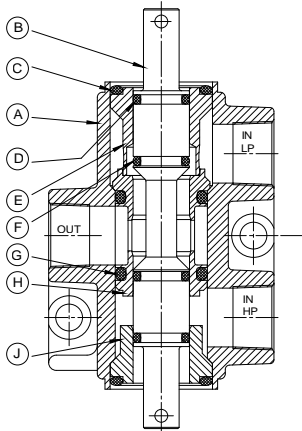

Approx. Weight = 2.93 lbs.
(1.33 kg)

LEGEND	PART NAME	PART NUMBER		UNITS REQUIRED
		3/8"	1/2"	
A	Body (Side Ports — EXPilot)	8401-01	8501-01	One
	Body (Side Ports — INPilot)	8421-01	8521-01	One
	δ Body (Sub-plate Mtg. — EXPilot)*	8511-01*		One
	δ Body (Sub-plate Mtg. — INPilot)*	8531-01*		One
B	Plunger	8502-02		One
C	"O" Ring	P-1000-19		Two
D	"O" Ring	P-1100-10		Two
E	Retainer	5502-43		One
F	"O" Ring	P-1100-10†		Two
G	"O" Ring	P-1000-17		Two
H	Bushing	8501-04		One
J	Bushing	4502-33		One

* Three P-1100-13 "O" Rings required for port gaskets on Sub-plate Mounting.
† Part No. for "T" Series changes to T-1000-10
δ Subplate mounting style bodies & body assemblies utilized with Treadle Actuators require addition of Suffix -3470 to part, subassembly and complete product number.

3/4", 1" AND 1 1/4" PORT SIZES

3/4" BODY ASSEMBLY** (2 position)

- SA-8602-62
(Side Ports — EXPilot)
- SA-8622-62
(Side Ports — INPilot)
- SA-8712-62
(Sub-plate Mtg. — EXPilot)
- SA-8732-62
(Sub-plate Mtg. — INPilot)

1" BODY ASSEMBLY** (2 position)

- SA-8702-62
(Side Ports — EXPilot)
- SA-8722-62
(Side Ports — INPilot)
- SA-8712-62
(Sub-plate Mtg. — EXPilot)
- SA-8732-62
(Sub-plate Mtg. — INPilot)

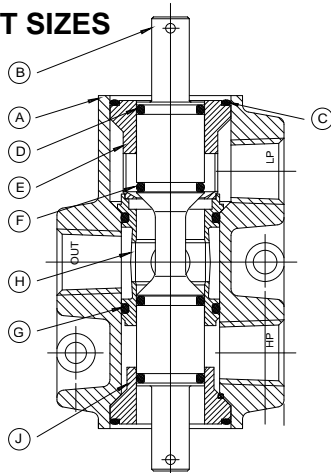

Approx. Weight = 7.65 lbs.
(3.47 kg)

(For 1 1/4" Valve Body Assemblies, add suffix detail "-12" to corresponding Sub-assembly No. shown for 1" valve.)

LEGEND	PART NAME	PART NUMBER			UNITS REQUIRED
		3/4"	1"	1 1/4"	
A	Body (Side Ports — EXPilot)	8601-01	8701-01	8701-01-12	One
	Body (Side Ports — INPilot)	8621-01	8721-01	8721-01-12	One
	Body (Sub-plate Mtg. — EXPilot)*	8711-01*		8711-01-12*	One
	Body (Sub-plate Mtg. — INPilot)*	8731-01*		8731-01-12*	One
B	Plunger	8701-02††			One
C	"O" Ring	P-1004-02	P-1004-02		Two
D	"O" Ring	P-1000-17	P-1000-24		Two
E	Retainer	5702-43	5702-43-12		One
F	"O" Ring	P-1000-17†	P-1000-20		Two
G	"O" Ring	P-1000-25	P-1000-27		Two
H	Bushing	8701-04	8702-04-12		One
J	Bearing	4702-33	4702-33-12		One

* Three P-1100-21 "O" Rings required for port gaskets on Sub-plate Mounting for 1" valve and three P-1000-23 "O" Rings for 1 1/4" valve.
† Part No. for "T" Series changes to T-1000-17
†† For use with Hand Lever Cap (L) add suffix -28B for 3/4" or 1" size, Suffix -12A for 1 1/4" size.

** For 3-position Body Assemblies with all ports blocked in neutral or center position, the only part that changes is the plunger. To indicate the 3-position plunger or Body Assembly, substitute the number "3" for the fourth digit of the part number shown. For example: 8503-02 is the 3-position plunger; SA-8503-72 is the 3-position Body Assembly.

PARTS LIST/BODY ASSEMBLY

Body Assembly Numbers are for "V" Series valves. For "T" Series, place the letter "T" in front of no. shown: i.e TSA-7202-62.

(TWO-OUTLET VALVES)

1/8" AND 1/4" PORT SIZES

1/8" BODY ASSEMBLY** (2 position)

- SA-7202-62
(Side Ports — EXPilot)
- SA-7222-62
(Side Ports — INPilot)
- SA-7312-62
(Sub-plate Mtg. — EXPilot)
- SA-7332-62
(Sub-plate Mtg. — INPilot)

1/4" BODY ASSEMBLY** (2 position)

- SA-7302-62
(Side Ports — EXPilot)
- SA-7322-62
(Side Ports — INPilot)
- SA-7312-62
(Sub-plate Mtg. — EXPilot)
- SA-7332-62
(Sub-plate Mtg. — INPilot)

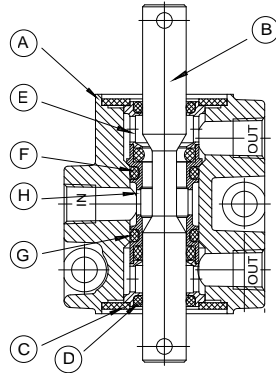

Approx. Weight = 1.12 lbs.
(0.51 kg)

LEGEND	PART NAME	PART NUMBER		UNITS REQUIRED
		1/8"	1/4"	
A	Body (Side Ports — EXPilot)	7201-01	7301-01	One
	Body (Side Ports — INPilot)	7221-01	7321-01	One
	Body (Sub-plate Mtg. — EXPilot)*	7311-01*		One
	Body (Sub-plate Mtg. — INPilot)*	7331-01*		One
B	Plunger	7302-02		One
C	Gasket	4302-44		Two
D	"O" Ring	P-1000-09		Two
E	Retainer	4302-43		Two
F	"O" Ring	P-1100-09†		Two
G	"O" Ring	P-1000-10		Two
H	Bushing	7301-04		One

*Two P-1100-09 "O" Rings required for port gaskets on Sub-plate Mounting.

† Part No. for "T" Series changes to T-1000-09

3/8" AND 1/2" PORT SIZES

3/8" BODY ASSEMBLY** (2 position)

- SA-7402-72
(Side Ports — EXPilot)
- SA-7422-72
(Side Ports — INPilot)
- δ SA-7512-72
(Sub-plate Mtg. — EXPilot)
- δ SA-7532-72
(Sub-plate Mtg. — INPilot)

1/2" BODY ASSEMBLY** (2 position)

- SA-7502-72
(Side Ports — EXPilot)
- SA-7522-72
(Side Ports — INPilot)
- δ SA-7512-72
(Sub-plate Mtg. — EXPilot)
- δ SA-7532-72
(Sub-plate Mtg. — INPilot)

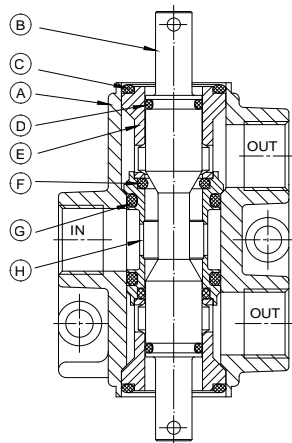

Approx. Weight = 2.93 lbs.
(1.33 kg)

LEGEND	PART NAME	PART NUMBER		UNITS REQUIRED
		3/8"	1/2"	
A	Body (Side Ports — EXPilot)	7401-01	7501-01	One
	Body (Side Ports — INPilot)	7421-01	7521-01	One
	δ Body (Sub-plate Mtg. — EXPilot)*	7511-01*		One
	δ Body (Sub-plate Mtg. — INPilot)*	7531-01*		One
B	Plunger	7502-02		One
C	"O" Ring	P-1000-19		Two
D	"O" Ring	P-1100-10		Two
E	Retainer	4502-43		Two
F	"O" Ring	P-1100-13†		Two
G	"O" Ring	P-1000-17		Two
H	Bushing	7501-04		One

* Three P-1100-13 "O" Rings required for port gaskets on Sub-plate Mounting.

† Part No. for "T" Series changes to T-1000-13

δ Subplate mounting style bodies & body assemblies utilized with Treadle Actuators require addition of Suffix -3470 to part, subassembly and complete product number.

3/4", 1" AND 1 1/4" PORT SIZES

3/4" BODY ASSEMBLY** (2 position)

- SA-7602-62
(Side Ports — EXPilot)
- SA-7622-62
(Side Ports — INPilot)
- SA-7712-62
(Sub-plate Mtg. — EXPilot)
- SA-7732-62
(Sub-plate Mtg. — INPilot)

1" BODY ASSEMBLY** (2 position)

- SA-7702-62
(Side Ports — EXPilot)
- SA-7722-62
(Side Ports — INPilot)
- SA-7712-62
(Sub-plate Mtg. — EXPilot)
- SA-7732-62
(Sub-plate Mtg. — INPilot)

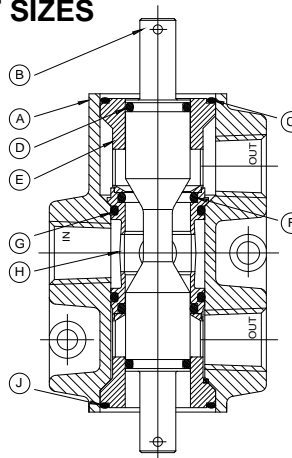

Approx. Weight = 7.65 lbs.
(3.47 kg)

(For 1 1/4" Valve Body Assemblies, add suffix detail "-12" to corresponding Sub-assembly No. shown for 1" valve.)

LEGEND	PART NAME	PART NUMBER			UNITS REQUIRED	
		3/4"	1"	1 1/4"		
A	Body (Side Ports — EXPilot)	7601-01	7701-01	7701-01-12	One	
	Body (Side Ports — INPilot)	7621-01	7721-01	7721-01-12	One	
	Body (Sub-plate Mtg. — EXPilot)*	7711-01*		7711-01-12*	One	
	Body (Sub-plate Mtg. — INPilot)*	7731-01*		7731-01-12*	One	
B	Plunger	7702-02††			One	
C	"O" Ring	P-1004-02			Two	
D	"O" Ring	P-1000-17		P-1100-24	Two	
E	Retainer	4702-43		4702-43-12	**	
F	"O" Ring	P-1100-21†		P-1000-24	Two	
G	"O" Ring	P-1000-25			Two	
H	Bushing	7701-04		7701-04-12	One	
J	Bearing	None			4702-33-12	One

* Three P-1100-21 "O" Rings required for port gaskets on Sub-plate Mounting for 1" valve and three P-1000-23 "O" Rings for 1 1/4" valve.

** Two required for 3/4" and 1" sizes. One required for 1 1/4" size.

† Part No. for "T" Series changes to T-1000-21

†† For use with Hand Lever Cap (L) add suffix -28B for 3/4" or 1" size, Suffix -12A for 1 1/4" size.

** For 3-position Body Assemblies with all ports blocked in neutral or center position, the only part that changes is the plunger. To indicate the 3-position plunger or Body Assembly, substitute the number "3" for the fourth digit of the part number shown. For example: 7503-02 is the 3-position plunger; SA-7503-72 is the 3-position Body Assembly.

PARTS LIST/BODY ASSEMBLY

(FOUR-WAY VALVES)

Body Assembly Numbers are for "V" Series valves. For "T" Series, place the letter "T" in front of no. shown: i.e TSA-4202-61.

1/8" AND 1/4" PORT SIZES

1/8" BODY ASSEMBLY** (2 position)

- SA-4202-61
(Side Ports — EXPilot)
- SA-4222-61
(Side Ports — INPilot)
- SA-4312-61
(Sub-plate Mtg. — EXPilot)
- SA-4332-61
(Sub-plate Mtg. — INPilot)

1/4" BODY ASSEMBLY** (2 position)

- SA-4302-61
(Side Ports — EXPilot)
- SA-4322-61
(Side Ports — INPilot)
- SA-4312-61
(Sub-plate Mtg. — EXPilot)
- SA-4332-61
(Sub-plate Mtg. — INPilot)

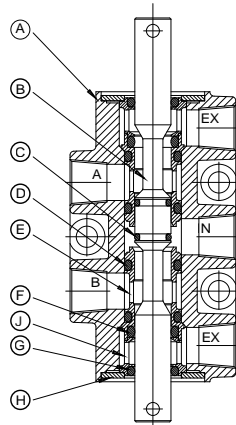

Approx. Weight = 1.70 lbs.
(0.77 kg)

LEGEND	PART NAME	PART NUMBER		UNITS REQUIRED
		1/8"	1/4"	
A	Body (Side Ports — EXPilot)	4201-01	4301-01	One
	Body (Side Ports — INPilot)	4221-01	4321-01	One
	Body (Sub-plate Mtg. — EXPilot)*		4312-01*	One
	Body (Sub-plate Mtg. — INPilot)*		4332-01*	One
B	Plunger		4302-05	One
C	"O" Ring	P-1100-06†		Two
D	"O" Ring	P-1000-10		Four
E	Bushing		4302-04	Two
F	"O" Ring	P-1100-09††		Two
G	"O" Ring	P-1000-09		Two
H	Gasket		4302-44	Two
J	Retainer		4302-43	Two

* Five P-1100-09 "O" Rings required for port gaskets on Sub-plate Mounting.

† Part No. for "T" Series changes to T-1000-06

†† Part No. for "T" Series changes to T-1000-09

3/8" AND 1/2" PORT SIZES

3/8" BODY ASSEMBLY** (2 position)

- SA-4402-71
(Side Ports — EXPilot)
- SA-4422-71
(Side Ports — INPilot)
- δ SA-4512-71
(Sub-plate Mtg. — EXPilot)
- δ SA-4532-71
(Sub-plate Mtg. — INPilot)

1/2" BODY ASSEMBLY** (2 position)

- SA-4502-71
(Side Ports — EXPilot)
- SA-4522-71
(Side Ports — INPilot)
- δ SA-4512-71
(Sub-plate Mtg. — EXPilot)
- δ SA-4532-71
(Sub-plate Mtg. — INPilot)

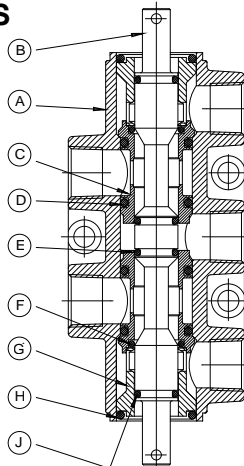

Approx. Weight = 4.25 lbs.
(1.93 kg)

LEGEND	PART NAME	PART NUMBER		UNITS REQUIRED
		3/8"	1/2"	
A	Body (Side Ports — EXPilot)	4402-01	4502-01	One
	Body (Side Ports — INPilot)	4422-01	4522-01	One
	δ Body (Sub-plate Mtg. — EXPilot)*		4512-01*	One
	δ Body (Sub-plate Mtg. — INPilot)*		4532-01*	One
B	Plunger		4502-05	One
C	Bushing		4502-04	Two
D	"O" Ring	P-1000-17		Four
E	"O" Ring	P-1100-10†		Two
F	"O" Ring	P-1100-13††		Two
G	Retainer		4502-43	Two
H	"O" Ring	P-1000-19		Two
J	"O" Ring		P-1000-10	Two

* Five P-1100-13 "O" Rings required for port gaskets on Sub-plate Mounting.

† Part No. for "T" Series changes to T-1000-10

†† Part No. for "T" Series changes to T-1000-13

δ Subplate mounting style bodies & body assemblies utilized with Treadle Actuators require addition of Suffix -3470 to part, subassembly and complete product number.

(For 1 1/4" Valve Body Assemblies, add suffix detail "-12" to corresponding Sub-assembly No. shown for 1" valve.)

3/4", 1" AND 1 1/4" PORT SIZES

3/4" BODY ASSEMBLY** (2 position)

- SA-4602-61
(Side Ports — EXPilot)
- SA-4622-61
(Side Ports — INPilot)
- SA-4712-61
(Sub-plate Mtg. — EXPilot)
- SA-4732-61
(Sub-plate Mtg. — INPilot)

1" BODY ASSEMBLY** (2 position)

- SA-4702-61
(Side Ports — EXPilot)
- SA-4722-61
(Side Ports — INPilot)
- SA-4712-61
(Sub-plate Mtg. — EXPilot)
- SA-4732-61
(Sub-plate Mtg. — INPilot)

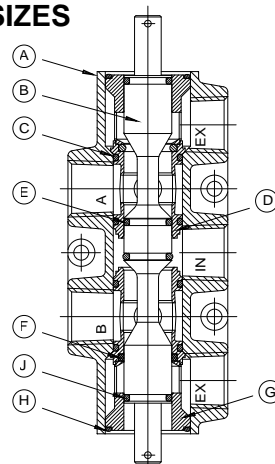

Approx. Weight = 11.4 lbs.
(5.17 kg)

LEGEND	PART NAME	PART NUMBER			UNITS REQ.
		3/4"	1"	1 1/4"	
A	Body (Side Ports — EXPilot)	4602-01	4702-01	4702-01-12	One
	Body (Side Ports — INPilot)	4622-01	4722-01	4722-01-12	One
	Body (Sub-plate Mtg. — EXPilot)*		4712-01*	4712-01-12*	One
	Body (Sub-plate Mtg. — INPilot)*		4732-01*	4732-01-12*	One
B	Plunger		4702-05††	4702-05-12††	One
C	"O" Ring	P-1000-25		P-1000-27	Four
D	Bushing		4702-04	4702-04-12	Two
E	"O" Ring	P-1100-17†		P-1100-20	Two
F	"O" Ring	P-1100-21†		P-1000-24	Two
G	Retainer		4702-43	4702-43-12	Two
H	"O" Ring	P-1004-02		P-1004-02	Two
J	"O" Ring	P-1000-17		P-1000-24	Two

* Five P-1100-21 "O" Rings required for port gaskets on Sub-plate Mounting for 1" valve and five P-1000-23 "O" Rings for 1 1/4" valve.

† Part No. for "T" Series changes to T-1000-17 and T-1000-21

†† For use with Hand Lever Cap (L) add suffix -28B for 3/4" or 1" size, Suffix -12A for 1 1/4" size.

** For 3-position Body Assemblies, the only part that changes is the plunger. There are 4 common plungers available, each one providing a different flow pattern. These flow patterns are illustrated on Page 35 (for other plunger configuration contact factory). Each flow pattern has its own number. To order the correct Body Assembly or Plunger, refer to Page 35. Substitute the proper flow pattern number for the fourth digit of either the Body Assembly or Plunger number. For Example: If you require Flow Pattern No. 3, the 1/8" Body Assembly number would be SA-4203-61. The Plunger would be 4303-05.

PARTS LIST/BODY ASSEMBLY

NOTE: Port markings "HP and "LP" have no significance other than to distinguish two separate inlet ports. INPILOT models have internal pilot supply from the "HP port, therefore the inlet pressure at this port should be within the minimum and maximum pilot pressures recommended for that particular valve. Body assembly numbers are for "V" series valves. For "T" series parts list, consult factory

(FIVE-WAY VALVES)

1/8" AND 1/4" PORT SIZES

1/8" BODY ASSEMBLY** (2 position)

- SA-5202-61
(Side Ports — EXPilot)
- SA-5222-61
(Side Ports — INPilot)
- SA-5312-61
(Sub-plate Mtg. — EXPilot)
- SA-5332-61
(Sub-plate Mtg. — INPilot)

1/4" BODY ASSEMBLY** (2 position)

- SA-5302-61
(Side Ports — EXPilot)
- SA-5322-61
(Side Ports — INPilot)
- SA-5312-61
(Sub-plate Mtg. — EXPilot)
- SA-5332-61
(Sub-plate Mtg. — INPilot)

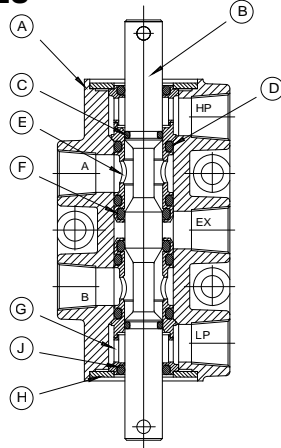

Approx. Weight = 1.7 lbs.
(0.77 kg)

LEGEND	PART NAME	PART NUMBER		UNITS REQUIRED
		1/8"	1/4"	
A	Body (Side Ports — EXPilot)	5202-01	5302-01	One
	Body (Side Ports — INPilot)	5222-01	5322-01	One
	Body (Sub-plate Mtg. — EXPilot)*		5312-01*	One
	Body (Sub-plate Mtg. — INPilot)*		5332-01*	One
B	Plunger		5302-05	One
C	"O" Ring	P-1100-06		Two
D	"O" Ring	P-1000-10		Four
E	Bushing	5302-04		Two
F	"O" Ring	P-1100-09		Two
G	Retainer	5302-43		Two
H	Gasket	4302-44		Two
J	"O" Ring	P-1000-09		Two

* Five P-1100-09 "O" Rings required for port gaskets on Sub-plate Mounting.

3/8" AND 1/2" PORT SIZES

3/8" BODY ASSEMBLY** (2 position)

- SA-5402-71
(Side Ports — EXPilot)
- SA-5422-71
(Side Ports — INPilot)
- ø SA-5512-71
(Sub-plate Mtg. — EXPilot)
- ø SA-5532-71
(Sub-plate Mtg. — INPilot)

1/2" BODY ASSEMBLY** (2 position)

- SA-5502-71
(Side Ports — EXPilot)
- SA-5522-71
(Side Ports — INPilot)
- ø SA-5512-71
(Sub-plate Mtg. — EXPilot)
- ø SA-5532-71
(Sub-plate Mtg. — INPilot)

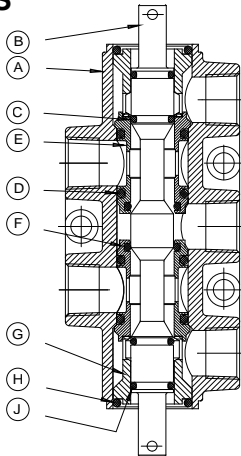

Approx. Weight = 4.25 lbs.
(1.93 kg)

LEGEND	PART NAME	PART NUMBER		UNITS REQUIRED
		3/8"	1/2"	
A	Body (Side Ports — EXPilot)	5402-01	5502-01	One
	Body (Side Ports — INPilot)	5422-01	5522-01	One
	ø Body (Sub-plate Mtg. — EXPilot)*		5512-01*	One
	ø Body (Sub-plate Mtg. — INPilot)*		5532-01*	One
B	Plunger		5502-05	One
C	"O" Ring	P-1100-10		Two
D	"O" Ring	P-1000-17		Four
E	Bushing	5502-04		Two
F	"O" Ring	P-1100-13		Two
G	Retainer	5502-43		Two
H	"O" Ring	P-1000-19		Two
J	"O" Ring	P-1000-10		Two

* Five P-1100-13 "O" Rings required for port gaskets on Sub-plate Mounting.

ø Subplate mounting style bodies & body assemblies utilized with Treadle Actuators require addition of Suffix -3470 to part, subassembly and complete product number.

3/4", 1" AND 1 1/4" PORT SIZES

3/4" BODY ASSEMBLY** (2 position)

- SA-5602-61
(Side Ports — EXPilot)
- SA-5622-61
(Side Ports — INPilot)
- SA-5712-61
(Sub-plate Mtg. — EXPilot)
- SA-5732-61
(Sub-plate Mtg. — INPilot)

1" BODY ASSEMBLY** (2 position)

- SA-5702-61
(Side Ports — EXPilot)
- SA-5722-61
(Side Ports — INPilot)
- SA-5712-61
(Sub-plate Mtg. — EXPilot)
- SA-5732-61
(Sub-plate Mtg. — INPilot)

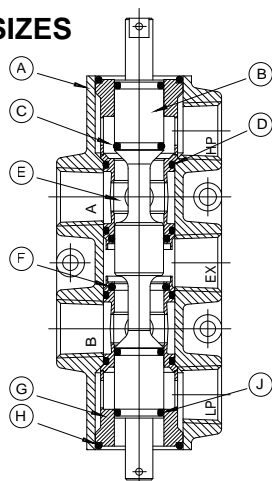

Approx. Weight = 11.4 lbs.
(5.17 kg)

(For 1 1/4" Valve Body Assemblies, add suffix detail "-12" to corresponding Sub-assembly No. shown for 1" valve.)

LEGEND	PART NAME	PART NUMBER			UNITS REQUIRED
		3/4"	1"	1 1/4"	
A	Body (Side Ports — EXPilot)	5602-01	5702-01	5702-01-12	One
	Body (Side Ports — INPilot)	5622-01	5722-01	5722-01-12	One
	Body (Sub-plate Mtg. — EXPilot)*		5712-01*	5712-01-12*	One
	Body (Sub-plate Mtg. — INPilot)*		5732-01*	5732-01-12*	One
B	Plunger		5702-05††	5702-05-12††	One
C	"O" Ring	P-1100-17		P-1100-20	Two
D	"O" Ring	P-1000-25		P-1000-27	Four
E	"Bushing	5702-04		5702-04-12	Two
F	"O" Ring	P-1100-21		P-1100-24	Two
G	Retainer	5702-43		5702-43-12	Two
H	"O" Ring	P-1004-02		P-1004-02	Two
J	"O" Ring	P-1000-17		P-1000-24	Two

* Five P-1100-21 "O" Rings required for port gaskets on Sub-plate Mounting for 1" valve and five P-1000-23 "O" Rings for 1 1/4" valve.

†† For use with Hand Lever Cap (L) add suffix -28B for 3/4" or 1" size, Suffix -12A for 1 1/4" size.

** For 3-position Body Assemblies, the only part that changes is the plunger. There are 4 common plungers available, each one providing a different flow pattern. These flow patterns are illustrated on Page 35 (for other plunger configuration contact factory). Each flow pattern has its own number.

To order the correct Body Assembly or Plunger, refer to page 43. Substitute the proper flow pattern number for the fourth digit of either the Body Assembly or Plunger number. For Example: If you require Flow Pattern No. 3, the 1/8" Body Assembly number would be SA-5203-61. The Plunger would be 5303-05

PARTS LIST/ACTUATORS

SOLENOID CAP ASSEMBLY (inline type) / all sizes (Non Hazardous Service)

designated by prefix letter "G" in complete product number

SA-4302-84 (EXPilot) SA-4322-84 (INPilot)

For 1/8" thru 1/2" valves

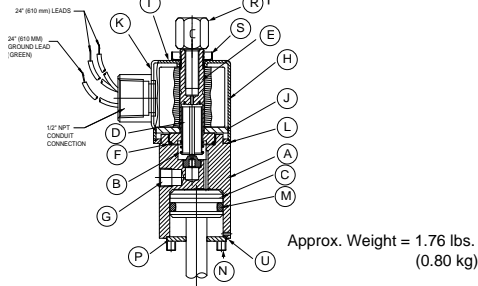

SA-4702-84 (EXPilot) SA-4702-84-12 (EXPilot)
SA-4722-84 (INPilot) SA-4722-84-12 (INPilot)

For 3/4" and 1" valves For 1 1/4" valves

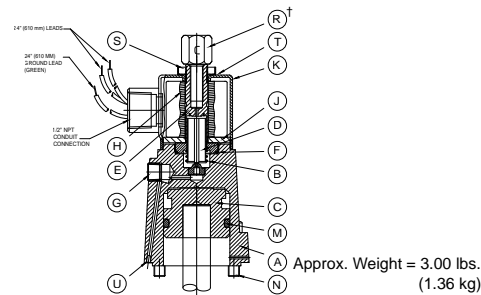

LEGEND	PART NAME	PART NUMBER		UNITS REQ'D
		1/8" thru 1/2"	3/4", 1" and 1 1/4"	
A	Solenoid Cap (INPilot)	4322-51	4722-51	One
	Solenoid Cap (EXPilot)	4302-51	4702-51	One
B	Spring	P-1002-07	P-1002-07	One
C	Piston	4302-07	4702-07*	One
D	Plunger	P-1002-08	P-1002-08	One
E	Sleeve	P-1002-04	P-1002-04	One
F	Gasket	P-1002-05	P-1002-05	One
G	1/8 NPT Plug (INPilot)	P-1022-02	P-1022-02	One
	1/8 NPT Plug (EXPilot)	NONE	NONE	None
H	Coil (Specify Coil Code)	P-1002-02	P-1002-02	One
J	Washer	P-1002-03	P-1002-03	One
K	Cover	P-1002-01	P-1002-01	One
L	Washer	4302-54	NONE	One
M	"O" Ring	P-1000-17	P-1000-23	One
N	Screw	PFS-1032-32	PAS-2528-16	Four
P	Washer	4302-02	NONE	One
R	Adapter (Hydraulic)†	P-1002-11†	P-1002-11†	One
S	Nut	P-1002-09	P-1002-09	One
T	Plate	P-1002-10	P-1002-10	One
U	Grommet (INPilot)	4302-52	4302-52	**
	Grommet (EXPilot)	4302-52B	4302-52B	**

*Piston part no. for 1 1/4" size is 4702-07-12.

**Two required for 1/8" thru 1/2" sizes. One required for 3/4", 1", and 1 1/4" sizes.

† Adapter "R" for piping solenoid discharge is supplied only if specified. Adapter is required when pilot medium is liquid. Specify on complete Valve or Sub-Assembly by using Suffix "-H" when ordering.

SOLENOID CAP ASSEMBLY (upright type) / all sizes *(Non Hazardous Service)

designated by prefix letter "G" and suffix letter "U" in complete product number

SA-4302-84-U (EXPilot) SA-4322-84-U (INPilot)

For 1/8" thru 1/2" valves

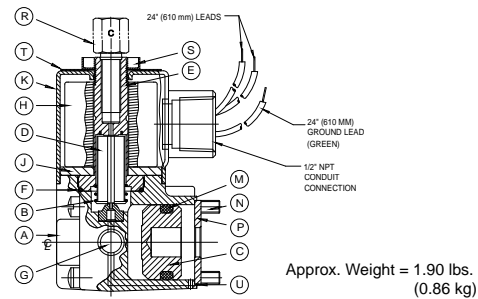

SA-4702-84-U (EXPilot) SA-4702-84-U-12 (EXPilot)
SA-4722-84-U (INPilot) SA-4722-84-U-12 (INPilot)

For 3/4" and 1" valves For 1 1/4" valves

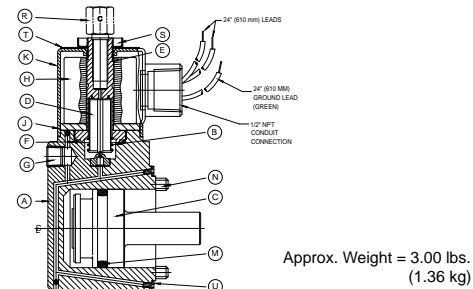

LEGEND	PART NAME	PART NUMBER		UNITS REQ'D
		1/8" thru 1/2"	3/4", 1" and 1 1/4"	
A	Solenoid Cap (INPilot)	4322-51U	4722-51U	One
	Solenoid Cap (EXPilot)	4302-51U	4702-51U	One
B	Spring	P-1002-07	P-1002-07	One
C	Piston	4302-07	4702-07*	One
D	Plunger	P-1002-08	P-1002-08	One
E	Sleeve	P-1002-04	P-1002-04	One
F	Gasket	P-1002-05	P-1002-05	One
G	1/8 NPT Plug (INPilot)	NONE	P-1022-02	One
	1/8 NPT Plug (EXPilot)	P-1022-02	NONE	One
H	Coil (Specify Coil Code)	P-1002-02	P-1002-02	One
J	Washer	P-1002-03	P-1002-03	One
K	Cover	P-1002-01	P-1002-01	One
M	"O" Ring	P-1000-17	P-1000-23	One
N	Screw	PFS-1032-32	PAS-2528-16	Four
P	Washer	4302-02	NONE	One
R	Adapter (Hydraulic)†	P-1002-11†	P-1002-11†	One
S	Nut	P-1002-09	P-1002-09	One
T	Plate	P-1002-10	P-1002-10	One
U	Grommet (INPilot)	4302-52	4302-52	Two
	Grommet (EXPilot)	4302-52B	4302-52B	Two

*Piston part no. for 1 1/4" size is 4702-07-12.

† Adapter "R" for piping solenoid discharge is supplied only if specified. Adapter is required when pilot medium is liquid. Specify on complete Valve or Sub-Assembly by using Suffix "-H" when ordering.

MANUAL OVERRIDE - Several types of manual overrides are available for use with solenoid actuators. Most parts listed above for specific actuators remain the same except for part A (solenoid cap) and parts for the specific override. Consult factory for correct part numbers.

***SOLENOID OPERATOR FOR HAZARDOUS LOCATIONS** - In many cases parts remain the same except for electrical operator. In order for unit to retain approvals and certifications it must be assembled and tested at the factory. Factory should be consulted for replacement parts.

PARTS LIST/ACTUATORS

SOLENOID SPRING-CENTER CAP ASSEMBLY (inline type) / all sizes (Non Hazardous Service)

designated by prefix letter "X" in complete product number

SA-4302-85 (EXPilot) SA-4322-85 (INPilot)
For 1/8" thru 1/2" valves

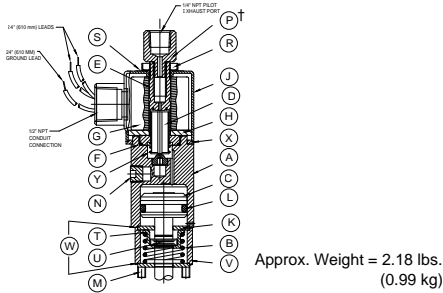

SA-4702-85 (EXPilot) SA-4702-85-12 (EXPilot)
SA-4722-85 (INPilot) SA-4722-85-12 (INPilot)
For 3/4" and 1" valves For 1 1/4" valves

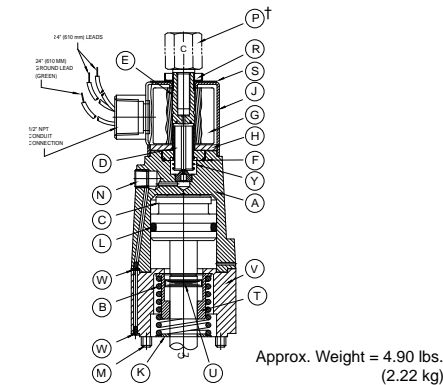

LEGEND	PART NAME	PART NUMBER		UNITS REQ'D
		1/8" thru 1/2"	3/4", 1" and 1 1/4"	
A	Solenoid Cap (INPilot)	4322-51	4722-51	One
	Solenoid Cap (EXPilot)	4302-51	4702-51	One
B	Spring	4302-06	4702-06	One
C	Piston	4302-38	4702-38*	One
D	Plunger	P-1002-08	P-1002-08	One
E	Sleeve	P-1002-04	P-1002-04	One
F	Gasket	P-1002-05	P-1002-05	One
G	Coil (Specify Coil Code)	P-1002-02	P-1002-02	One
H	Washer	P-1002-03	P-1002-03	One
J	Cover	P-1002-01	P-1002-01	One
K	Washer**	4302-02**	4702-02**	**
L	"O" Ring	P-1000-17	P-1000-23	One
M	Screw	PFS-1032-48	PAS-2528-40	Four
N	Plug (INPilot)	P-1022-02	P-1022-02	One
	Plug (EXPilot)	NONE	NONE	None
P	Adapter (Hydraulic)†	P-1002-11†	P-1002-11†	One
R	Nut	P-1002-09	P-1002-09	One
S	Plate	P-1002-10	P-1002-10	One
T	Spring Cup	4302-14	4702-14*	One
U	Pin	4302-22	4702-22	One
V	Spacer (INPilot)	4322-32D	4722-32D	One
	Spacer (EXPilot)	4302-32D	4702-32D	One
W	Grommet (INPilot)	4302-52	4302-52	***
	Grommet (EXPilot)	4302-52B	4302-52B	***
X	Solenoid Ring	4302-54	NONE	One
Y	Spring	P-1002-07	P-1002-07	One

* For 1 1/4" size Piston part no. is 4702-38-12, Spring Cup part no. is 4702-31-12.

** Two required for 1/8" thru 1/2" sizes. One required for 3/4" & 1". None for 1 1/4".

*** Four required for 1/8" thru 1/2" sizes. Two required for 3/4", 1" and 1 1/4" sizes.

† Adapter "P" for piping solenoid discharge is supplied only if specified. Specify on complete Valve or Sub-Assembly by using Suffix "-H" when ordering.

SOLENOID SPRING-CENTER CAP ASSEMBLY (upright type) / all sizes (Non Hazardous Service)

designated by prefix letter "X" and suffix letter "U" in complete product number

SA-4302-85-U (EXPilot) SA-4322-85-U (INPilot)
For 1/8" thru 1/2" valves

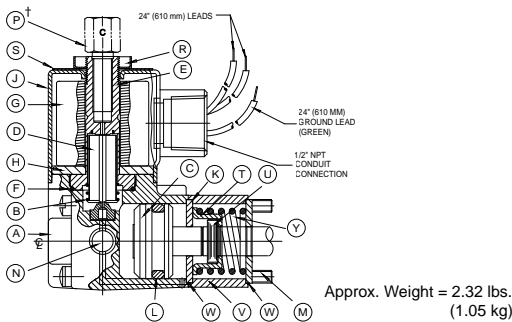

SA-4702-85-U (EXPilot) SA-4702-85-U-12 (EXPilot)
SA-4722-85-U (INPilot) SA-4722-85-U-12 (INPilot)
For 3/4" and 1" valves For 1 1/4" valves

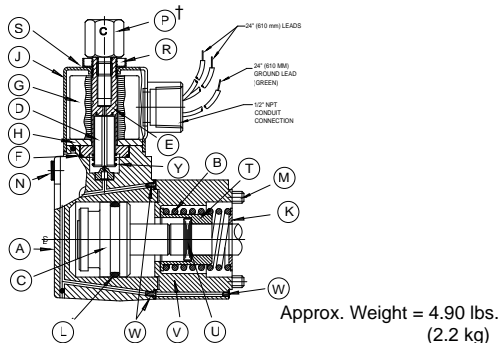

LEGEND	PART NAME	PART NUMBER		UNITS REQ'D
		1/8" thru 1/2"	3/4", 1" and 1 1/4"	
A	Solenoid Cap (INPilot)	4322-51U	4722-51U	One
	Solenoid Cap (EXPilot)	4302-51U	4702-51U	One
B	Spring	4302-06	4702-06	One
C	Piston	4302-38	4702-38*	One
D	Plunger	P-1002-08	P-1002-08	One
E	Sleeve	P-1002-04	P-1002-04	One
F	Gasket	P-1002-05	P-1002-05	One
G	Coil (Specify Coil Code)	P-1002-02	P-1002-02	One
H	Washer	P-1002-03	P-1002-03	One
J	Cover	P-1002-01	P-1002-01	One
K	Washer**	4302-02**	4702-02**	**
L	"O" Ring	P-1000-17	P-1000-23	One
M	Screw	PFS-1032-48	PAS-2528-40	Four
N	Plug (INPilot)	P-1022-02	P-1022-02	One
	Plug (EXPilot)	NONE	NONE	None
P	Adapter (Hydraulic)†	P-1002-11†	P-1002-11†	One
R	Nut	P-1002-09	P-1002-09	One
S	Plate	P-1002-10	P-1002-10	One
T	Spring Cup	4302-14	4702-14*	One
U	Pin	4302-22	4702-22	One
V	Spacer (INPilot)	4322-32D	4722-32D	One
	Spacer (EXPilot)	4302-32D	4702-32D	One
W	Grommet (INPilot)	4302-52	4302-52	***
	Grommet (EXPilot)	4302-52B	4302-52B	***
Y	Spring	P-1002-07	P-1002-07	One

* For 1 1/4" size Piston part no. is 4702-38-12, Spring Cup part no. is 4702-31-12.

** Two required for 1/8" thru 1/2" sizes. One required for 3/4" & 1". None for 1 1/4".

*** Four required for 1/8" thru 1/2" sizes. Two required for 3/4", 1" and 1 1/4" sizes.

† Adapter "P" for piping solenoid discharge is supplied only if specified. Specify on complete Valve or Sub-Assembly by using Suffix "-H" when ordering.

FOR MANUAL OVERRIDE OR
*SOLENOID OPERATOR FOR HAZARDOUS LOCATIONS }

See bottom of page 56 for notes.

PARTS LIST/ACTUATORS

HAND CAP ASSEMBLY (offset mounted) / 1/8" thru 1" only

designated by prefix letter "H" in complete product number

SA-4302-69

For 1/8" thru 1/2" valves

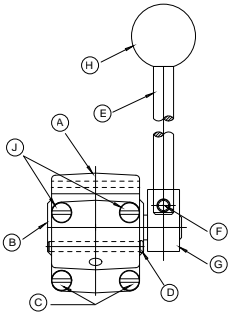

Approx. Weight = 0.72 lbs.
(0.33 kg)

SA-4702-69

For 3/4" and 1" valves

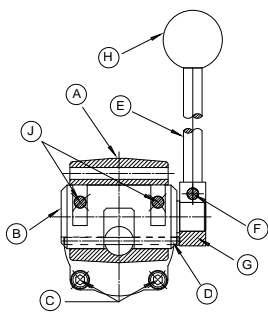

Approx. Weight = 2.20 lbs.
(1.00 kg)

LEGEND	PART NAME	PART NUMBER		UNITS REQ'D
		1/8" thru 1/2"	3/4" and 1"	
A	Tumbler Cap	4302-18	4702-18	One
B	Tumbler	4302-19	4702-19	One
C	Screw	PFS-1032-08	PAS-2528-10	Two
D	Pin	4302-20	4702-20	One
E	Handle	4302-24	4702-24	One
F	Screw	PFS-1032-08	PAS-2528-16	One
G	Clamp	4302-23	4702-23	One
H	Ball	P-1001-08	P-1001-10	One
J	Screw	PFS-1032-24	PAS-2528-32	Two

HAND LEVER CAP ASSEMBLY (centerline mounted) / all sizes

SA-4302-69L

For 1/8" thru 1/2" valves

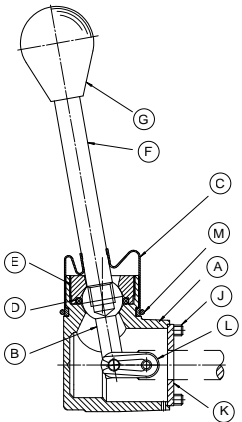

Approx. Weight = 0.80 lbs.
(0.36 kg)

SA-4702-69L

For 3/4" and 1" valves

SA-4702-69L-12

For 1/4" valves

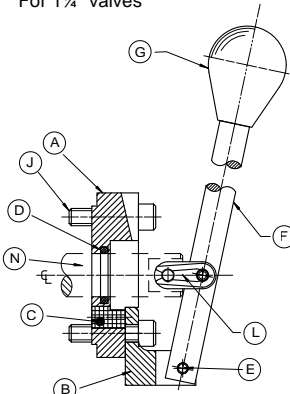

Approx. Weight = 1.50 lbs.
(0.68 kg)

designated by prefix letter "L" in complete product number

LEGEND	PART NAME	PART NUMBER			UNITS REQ'D
		1/8" thru 1/2"	3/4" and 1"	11/4"	
A	Lever Cap	4302-18L	4702-18L	4702-18L-12	One
B	Knuckle	4302-23D	NONE	NONE	One
	Bracket	NONE	4702-23L	4702-23L	One
C	Gland Boot	4302-19D	NONE	NONE	One
	Filter	NONE	4702-19L	4702-19L	One
D	"O" Ring	P-1100-13	P-1000-12	P-1000-09	One
E	Screw	4302-20D	NONE	NONE	One
	Pin	NONE	4302-27	4302-27	One
F	Handle	4302-24D	4702-24L	4702-24L	One
G	Knob	P-1001-10D	P-1001-10D	P-1001-10D	One
J	Screw	PFS-1032-24	PAS-2528-16	PAS-2528-32	Four
K	Washer	4302-02	NONE	NONE	One
L	Link Assembly	4302-83	4302-83	4302-83	One
M	Clip	4302-22D	NONE	NONE	One
	Screw (Not Shown)	NONE	PSS-1032-04	PSS-1032-04	One
N	Rod	NONE	NONE	4702-19L-12	One

*Applicable to all 3/4" and 1" sizes, but Body Assembly used must be made to Suffix option "-28B".

BUTTON CAP ASSEMBLY / 1/8" thru 1" only

SA-4302-86

For 1/8" thru 1/2" valves

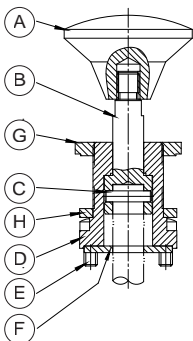

Approx. Weight = 0.5 lbs.
(0.23 kg)

SA-4702-86

For 3/4" and 1" valves

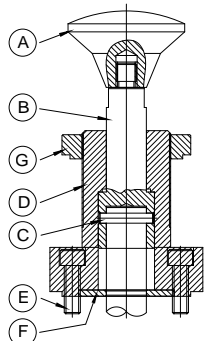

Approx. Weight = 1.0 lbs.
(0.45 kg)

designated by prefix letter "I" in complete product number.

LEGEND	PART NAME	PART NUMBER		UNITS REQ'D
		1/8" thru 1/2"	3/4" and 1"	
A	Lid Knob	4302-65-125	4302-65-125	One
B	Rod	4302-67-125	4702-67-125	One
C	Pin	4302-22	4702-22	One
D	Button Cap	4302-66P	4702-66P	One
E	Screw	PFS-1032-08	PAS-2528-12	Four
F	Washer	4302-02	4702-02-500	One
G	Locking Nut	4302-68	4702-68	One
H	Washer	4302-69	NONE	One

PARTS LIST/ACTUATORS

CAM CAP ASSEMBLY / 1/8" thru 1" only

designated by prefix letter "C" in complete product number.

SA-4302-66

For 1/8" thru 1/2" valves

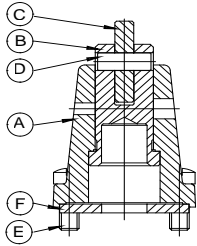

SA-4702-66

For 3/4" and 1" valves

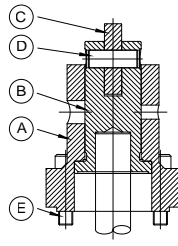

Approx. Weight = 0.45 lbs. (0.20 kg)

Approx. Weight = 2.01 lbs. (0.91 kg)

LEGEND	PART NAME	PART NUMBER		UNITS REQUIRED
		1/8" thru 1/2"	3/4" and 1"	
A	Cam Cap	4302-13	4702-13	One
B	Yoke	4302-15	4702-15	One
C	Roller	4302-16	4702-16	One
D	Pin	4302-21	4702-21	One
E	Screw	PFS-1032-08	PAS-2528-16	Four
F	Washer	4302-02	None	One

CAM CAP ASSEMBLY (heavy duty) 1/8" thru 1/2" only

with 1/4" overtravel

designated by prefix letter "C" and suffix "-18S" in complete product number.

SA-4302-66-18S

For 1/8" thru 1/2" valves

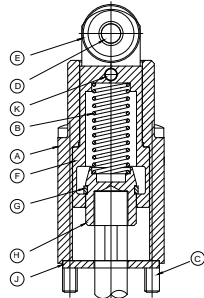

Approx. Weight = 1.00 lbs. (0.45 kg)

LEGEND	PART NAME	PART NUMBER		UNITS REQUIRED
		1/8" thru 1/2"		
A	Cam Cap	4302-13-18		One
B	Spring	4302-06-18S		One
C	Screw	PFS-1032-32C		Four
D	Pin	4302-21-18		One
E	Roller	4302-16-18C		One
F	Yoke	4302-15-18		One
G	Spring Clip	4302-70-18		One
H	Spring Cup	4302-14-18		One
J	Washer	4302-02		One
K	Pin	4302-22-18		One

FOOT CAP ASSEMBLY (treadle and pedal) 1/8" thru 1" only

Pedal Cap is designated by prefix letter "F" in complete product number.
Treadle Cap is designated by prefix letter "T" in complete product number.

SA-4302-68 (Pedal) SA-4302-67 (Treadle)

For 1/8" thru 1/2" valves

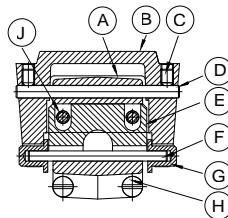

Approx. Weight
Pedal = 1.04 lbs (0.47 kg)
Treadle = 1.13 lbs. (0.51 kg)

SA-4702-68 (Pedal) SA-4702-67 (Treadle)

For 3/4" and 1" valves

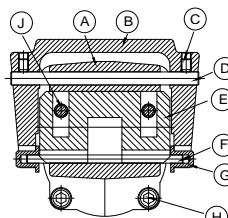

Approx. Weight
Pedal = 3.05 lbs. (1.38 kg)
Treadle = 3.10 lbs. (1.41 kg)

LEGEND	PART NAME	PART NUMBER		UNITS REQUIRED
		1/8" thru 1/2"	3/4" and 1"	
A	Tumbler Cap	4302-18	4702-18	One
B	Pedal*	4302-30*	4702-30*	One
	Treadle*	4302-26*	4702-26*	One
C	Screw	PSS-1032-04	PSS-1032-04	Two
D	Pin	4302-28	4702-28	One
E	Tumbler	4302-25	4702-25	One
F	Pin	4302-27	4702-27	One
G	Button	4302-29	4302-29	Two
H	Screw	PFS-1032-08	PAS-2528-10	Two
J	Screw	PFS-1032-24	PAS-2528-32	Two

* these parts are interchangeable within the same valve size.

RETAINING CAP ASSEMBLY / 1/8" thru 1" only

designated by prefix letter "A" and suffix number "-33" in complete product number.

CA-4302-32-33

For 1/8" thru 1/2" valves

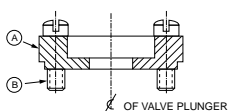

Approx. Weight
1/8" thru 1/2" = 0.20 lbs. (0.09 kg)
3/4" and 1" = 0.50 lbs. (0.23 kg)

CA-4702-32-33

For 3/4" and 1" valves

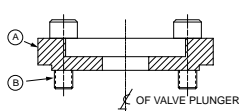

LEGEND	PART NAME	PART NUMBER		UNITS REQUIRED
		1/8" thru 1/2"	3/4" and 1"	
A	Retaining Cap	4302-32-33	4702-32-33	One
B	Screw	PFS-1032-08	PAS-2528-10	Four

The RETAINING CAP ASSEMBLY is used when it is necessary for the valve plunger to extend thru the end of the valve. An example might be when it is desired to connect two valves in tandem such that one actuator controls two valves.

PARTS LIST/ACTUATORS

PILOT CAP ASSEMBLY / all sizes

SA-4302-64
(Pressure Pilot)
SA-4322-64
(Bleed Pilot)

For 1/8" thru 1/2" valves

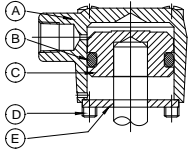

Approx. Weight = 0.58 lbs.
(0.26 kg)

SA-4702-64** .
(Pressure Pilot)
SA-4722-64**
(Bleed Pilot)

For 3/4" and 1" valves

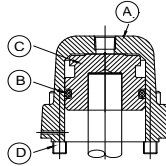

Approx. Weight = 1.70 lbs.
(0.77 kg)

Pressure pilot (EXPIlot) is designated by prefix letter "P" in complete product number.
Bleed pilot (INPIlot) is designated by prefix letter "P" and suffix option "-1" in complete product number.

LEGEND	PART NAME	PART NUMBER		UNITS REQ'D
		1/8" thru 1/2"	3/4", 1" and 1 1/4"	
A	Pilot Cap	4302-11	4702-11	One
	Bleed Pilot Cap	4322-11	4722-11	One
B	"O" Ring	P-1000-17	P-1000-23	One
C	Piston	4302-07	4702-07**	One
D	Screw	PFS-1032-20	PAS-2528-16	Four
E	Washer	4302-02	NONE	One
F	Grommet* (Not Shown)	4302-52H*	4302-52H*	Two

*Bleed Pilot Parts. Two required for 1/8" thru 1/2" size. One required for 3/4" thru 1 1/4" size.

**For 1 1/4" size add suffix "-12" to part number shown.

DIFFERENTIAL PILOT CAP ASSEMBLY / all sizes

SA-4302-75
(EXPIlot)
SA-4322-75
(INPIlot)

For 1/8" thru 1/2" valves

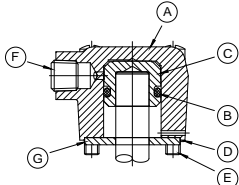

Approx. Weight = 0.68 lbs.
(0.31 kg)

SA-4702-75
(EXPIlot)*
SA-4722-75
(EXPIlot)*

For 3/4" and 1" valves

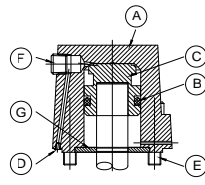

Approx. Weight = 2.10 lbs.
(0.95 kg)

designated by prefix letter "K" in complete product number.

LEGEND	PART NAME	PART NUMBER		UNITS REQ'D
		1/8" thru 1/2"	3/4", 1" and 1 1/4"	
A	Differential- Pilot Cap	4322-09	4722-09	One
B	"O" Ring	P-1000-11	P-1000-17	One
C	Piston	4302-08	4702-08*	One
D	Grommet** (INPIlot)	4302-52**	4302-52**	**
	Grommet** (EXPIlot)	4302-52B**	4302-52B**	**
E	Screw	PFS-1032-20	PAS-2528-16	Four
F	1/8 NPT Plug (INPIlot)	P-1022-02	P-1022-02	One
G	Washer	4302-02	4702-02-500†	One

*For 1 1/4" size add suffix "-12" to part no. shown.

**Two required for 1/8" thru 1/2" size. One required for 3/4", 1", and 1 1/4" size.

†None required for 1 1/4" size

DIAPHRAGM CAP ASSEMBLY/ all sizes

SA-4302-87-31

For 1/8" thru 1/2" valves

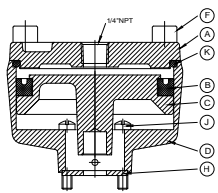

Approx. Weight = 1.3 lbs.
(0.59 kg)

SA-4702-87*

For 3/4" and 1" valves

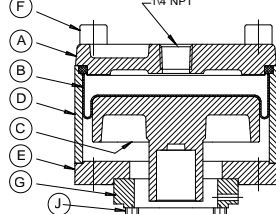

Approx. Weight = 2.0 lbs.
(0.91 kg)

designated by prefix letter "W" in complete product number.

LEGEND	PART NAME	PART NUMBER			UNITS REQ'D
		1/8" thru 1/2"	3/4" and 1"*	1 1/4"	
A	Top Plate	4302-71N**	4302-71N	4302-71N**	One
B	Seal	P-1016-34	4302-77	P-1016-34	One
C	Piston	4302-75-31-1B	4702-75	4702-75-12-31	One
D	Cylinder	4302-76-78	4702-72	4702-72-12-31	One
E	Bottom Plate	NONE	4702-76	4702-76	One
F	Screw	PAS-3124-12	PAS-3124-36	PAS-3124-40	Four
G	Spacer	NONE	4702-78	4702-78	One
H	Washer	4302-02	NONE	NONE	One
J	Screw	PFS-1032-18	PAS-2528-16	PAS-2528-16	Four

*For 1 1/4" size add suffix "-12-31" to part no. shown.

**Also required one P-1004-11 Top Plate O-Ring Seal, ITEM K.

DETENT CAP ASSEMBLY / 1/8" thru 1" only

SA-4302-81
(3 position detent)
SA-4302-82
(2 position detent)

For 1/8" thru 1/2" valves

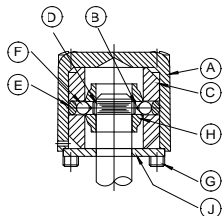

Approx. Weight = 1.3 lbs.
(0.59 kg)

SA-4702-81
(3 position detent)
SA-4702-82
(2 position detent)

For 3/4" and 1" valves

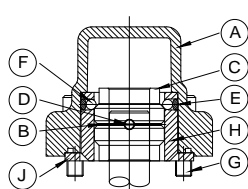

Approx. Weight = 2.0 lbs.
(0.91 kg)

Two detent is designated by prefix letter "Z" in complete product number.

Three detent is designated by prefix letter "U" in complete product number.

LEGEND	PART NAME	PART NUMBER		UNITS REQ'D
		1/8" thru 1/2"	3/4" and 1"*	
A	Spring Cap	4302-12	4702-12	One
B	Spring Clip (Three Detent)	4302-87	4702-87	One
	Spring Clip (Two Detent)	NONE	NONE	None
C	Detent (Three Position)	4302-56	4702-56	One
	Detent (Two Position)	4302-57	4702-57	One
D	Pin (Three Detent)	4302-58	4702-58	One
	Pin (Two Detent)	4302-58A	4702-58A	One
E	"O" Ring	P-1000-17	P-1000-23	One
F	Ball	P-1003-05*	P-1003-05*	*
G	Screw	PFS-1032-20	PAS-2528-16	Four
H	Cage	4302-55	4702-55	One
J	Washer	4302-02	4702-02A	One

*Six required for 1/8" thru 1/2" size. Twelve required for 3/4" and 1" size.

PARTS LIST/ACTUATORS

SPRING CAP ASSEMBLY/ all sizes

SA-4302-65
SA-4302-71
(no spring)

For 1/8" thru 1/2" valves

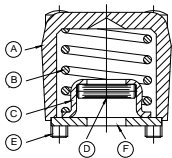

Approx. Weight = 0.48 lbs.
(0.22 kg)

SA-4702-65**
SA-4702-71**
(no spring)

For 3/4" and 1" valves

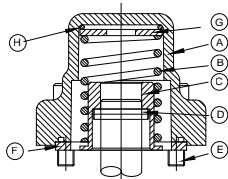

Approx. Weight = 0.60 lbs.
(0.27 kg)

Spring Return designated by prefix letter "S" in complete product number.
No Spring Return designated by prefix letter "N" in complete product number.

LEGEND	PART NAME	PART NUMBER			UNITS REQ'D
		1/8" thru 1/2"	3/4" and 1"	1 1/4"	
A	Spring Cap	4302-12	4702-12	4702-12	One
B	Spring*	4302-06*	4702-06*	4702-06*	One
C	Spring Cup*	4302-14*	4702-14*	4702-14-12*	One
D	Pin*	4302-22*	4702-22*	NONE	One
E	Screw	PFS-1032-20	PAS-2528-16	PAS-2528-16	Four
F	Washer	4302-02	4702-02A†	4702-02A	One
G	Washer*	NONE	4302-02*	NONE	One
H	"O" Ring*	NONE	P-1000-024*	NONE	One

* Omit for "No Spring Cap" Assembly.

** For 1 1/4" size add suffix "-12" to part number shown.

† For SA-4702-71, use 4702-02R

SPRING-CENTER CAP ASSEMBLY (manually operated valve) / all sizes

SA-4302-72

For 1/8" thru 1/2" valves

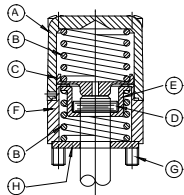

Approx. Weight = 0.75 lbs.
(0.34 kg)

SA-4702-72*

For 3/4" and 1" valves

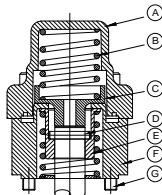

Approx. Weight = 2.35 lbs.
(1.07 kg)

designated by prefix letter "B" in complete product number.

LEGEND	PART NAME	PART NUMBER			UNITS REQ'D
		1/8" thru 1/2"	3/4" and 1"	1 1/4"	
A	Spring Cap	4302-12	4702-12	4702-34-12	One
B	Spring	4302-06	4702-06	4702-06	Two
C	Cup Washer	4302-31	4702-31	4702-36-12	One
D	Pin	4302-22	4702-22	NONE	One
E	Spring Cup	4302-14	4702-14	NONE	One
F	Spacer	4302-10D	4702-10D	NONE	One
G	Screw	PFS-1032-32	PAS-2528-36	PAS-2528-40	Four
H	Washer	4302-02	4702-02	NONE	One
J	Rod (Not Shown)	NONE	NONE	4702-35-12	One

* For 1 1/4" size add suffix "-12" to part number shown.

PILOT SPRING-CENTER CAP ASSEMBLY/ all sizes

SA-4302-83

For 1/8" thru 1/2" valves

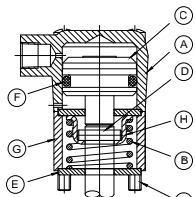

Approx. Weight = 1.00 lbs.
(0.45 kg)

SA-4702-83*

For 3/4" and 1" valves

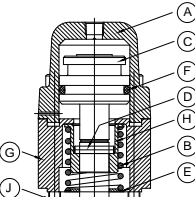

Approx. Weight = 3.60 lbs.
(1.63 kg)

designated by prefix letter "J" in complete product number.

LEGEND	PART NAME	PART NUMBER			UNITS REQ'D
		1/8" thru 1/2"	3/4" and 1"	1 1/4"	
A	Pilot Cap	4302-11	4702-11	4702-11	One
B	Spring	4302-06	4702-06	4702-06	One
C	Piston	4302-38	4702-38	4702-38-12	One
D	Pin	4302-22	4702-22	NONE	One
E	Washer	4302-02	4702-02	NONE	**
F	"O" Ring	P-1000-17	P-1000-23	P-1000-23	One
G	Pilot Spacer	4302-32D	4702-32D	4702-32D	One
H	Spring Cup	4302-14	4702-14	4702-31-12	One
J	Screw	PFS-1032-36	PAS-2528-40	PAS-2528-40	Four

* For 1 1/4" size add suffix "-12" to part number shown.

** Two required for 1/8" thru 1/2" size. One required for 3/4", and 1" size

DIAPHRAGM SPRING-CENTER CAP ASSEMBLY/ all sizes

SA-4302-88-31

For 1/8" thru 1/2" valves

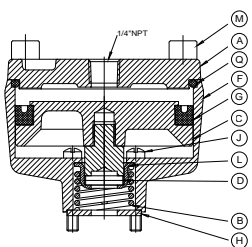

Approx. Weight = 1.5 lbs.
(0.68 kg)

SA-4702-88*

For 3/4" and 1" valves

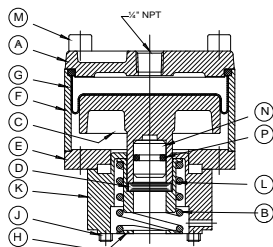

Approx. Weight = 2.5 lbs.
(1.13 kg)

designated by prefix letter "Y" in complete product number.

LEGEND	PART NAME	PART NUMBER			UNITS REQ'D
		1/8" thru 1/2"	3/4" and 1"	1 1/4"	
A	Top Plate	4302-71N**	4302-71N	4302-71N**	One
B	Spring	4302-06	4702-06	4702-06	One
C	Piston	4302-73-31A	4702-75	4702-73-12-31	One
D	Pin	4302-22	4702-22	NONE	One
E	Bottom Plate	NONE	4702-76	4702-76	One
F	Cylinder	4302-76-10Y	4702-72	4702-72-12-31	One
G	Seal	P-1016-34	4302-77	P-1016-34	One
H	Washer	4302-02	4702-02	NONE	One
J	Screw	PFS-1032-20	PAS-2528-28	PAS-2528-28	Four
K	Spacer	NONE	4702-10Y	4702-10Y	One
L	Spring Cup	4302-14	4702-14	4702-31-12	One
M	Screw	PAS-3124-12	PAS-3124-36	PAS-3124-40	Four
N	Spacer	NONE	4702-75-1	NONE	One
P	"O" Ring	NONE	P-1000-09	NONE	One

* For 1 1/4" size add suffix "-12-31" to part no. shown.

** Also requires one P-1004-11 Top Plate O-Ring Seal, ITEM Q.

Combination Actuators

Combination Actuators are a combining of two actuating devices into one unit that can be applied to either end of a valve body assembly. This allows for a third actuating device to be applied to the opposite end of the valve body assembly.

Use of Combination Actuators allows for control of various interlock circuits, and in many cases reduces the total number of valves and overall circuitry required for control of intricate systems.

Those combination actuators, shown below, that are indicated with the asterisk symbol * are considered non-

standard as they require body assemblies with extended plungers. If a valve can be re-configured to utilize one of the combination actuators that is not indicated with the asterisk symbol *, standard body assemblies can be utilized. Consult factory for application assistance.

Cross section drawings and descriptions are presented here for understanding of actuator function. They are indicated in the product number by use of the prefix "A" and the appropriate suffix that represents the specific Combination Actuator involved.

Manual

* Hand Lever-Two Detent Cap Assembly CA-4302-69L-113L For 1/8" Thru 1/2" Valves

This Cap Assembly is denoted in the prefix letters of the valve product no. by the letter "A" and suffix detail "-113L."

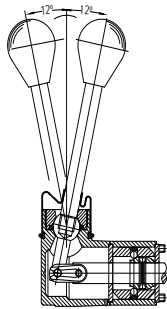

* Hand Lever-Three Detent Cap Assembly CA-4302-69L-114L For 1/8" Thru 1/2" Valves

This Cap Assembly is denoted in the prefix letters of the valve product no. by the letter "A" and suffix detail "-114L."

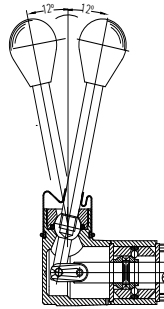

* Hand Lever-Spring Return (S) Cap Assembly CA-4302-69L-130L For 1/8" Thru 1/2" Valves

This Cap Assembly is denoted in the prefix letters of the valve product no. by the letter "A" and suffix detail "-130L."

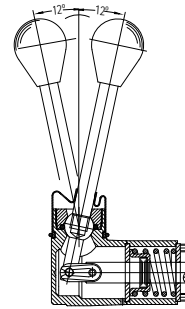

* Hand Lever-Spring Center (D — One Direction) Cap Assembly CA-4302-69L-135L For 1/8" Thru 1/2" Valves

This Cap Assembly is denoted in the prefix letters of the valve product no. by the letter "A" and suffix detail "-135L."

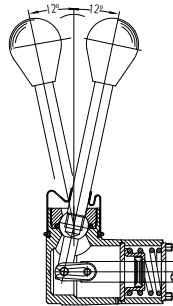

* Button-Two Detent Cap Assembly CA-4302-86L-115 For 1/8" Thru 1/2" Valves

This Cap Assembly is denoted in the prefix letters of the valve product no. by the letter "A" and suffix detail "-115."

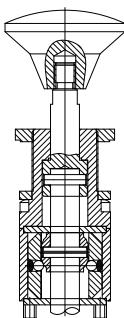

* Button-Spring Return (S) Cap Assembly CA-4302-86-136 For 1/8" Thru 1/2" Valves

This Cap Assembly is denoted in the prefix letters of the valve product no. by the letter "A" and suffix detail "-136."

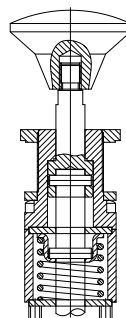

* Button-Spring Center (D-One Direction) Cap Assembly CA-4302-86-201 For 1/8" Thru 1/2" Valves

This Cap Assembly is denoted in the prefix letters of the valve product no. by the letter "A" and suffix detail "-201."

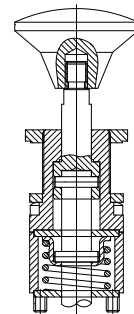

Combination Actuators

Manual (Continued)

* Hand-Two Detent Cap Assembly CA-4302-69-113

For 1/8" Thru 1/2" Valves

This Cap Assembly is denoted in the prefix letters of the valve product no. by the letter "A" and suffix detail "-113."

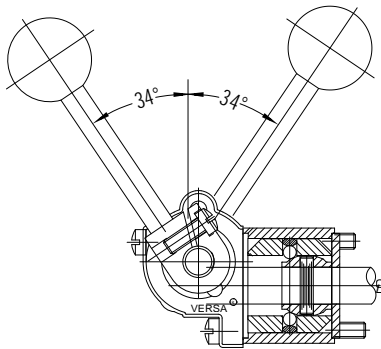

* Hand-Three Detent Cap Assembly CA-4302-69-114

For 1/8" Thru 1/2" Valves

This Cap Assembly is denoted in the prefix letters of the valve product no. by the letter "A" and suffix detail "-114."

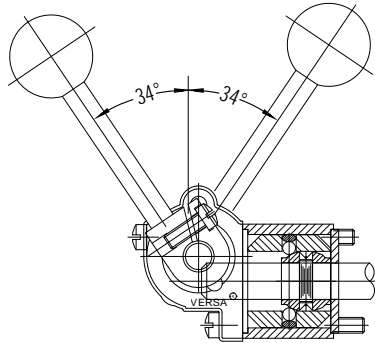

* Hand-Spring Center (D – One Direction) Cap Assembly CA-4302-69-135

For 1/8" Thru 1/2" Valves

This Cap Assembly is denoted in the prefix letters of the valve product no. by the letter "A" and suffix detail "-135."

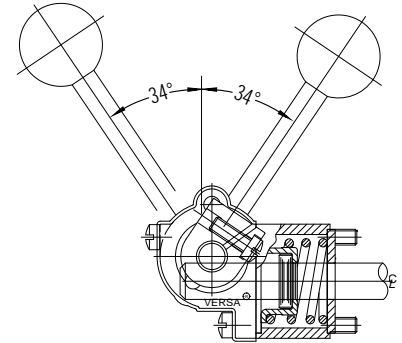

* Hand-Spring Return (R) Cap Assembly CA-4302-69-130A

For 1/8" Thru 1/2" Valves

This Cap Assembly is denoted in the prefix letters of the valve product no. by the letter "A" and suffix detail "-130A"

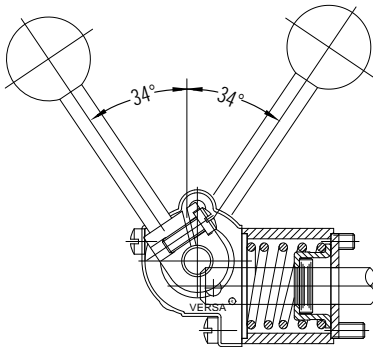

Miscellaneous Single Detent-Spring Center (D – One Direction) Cap Assembly CA-4302-74-111

For 1/8" Thru 1/2" Valves

This Cap Assembly is denoted in the prefix letters of the valve product no. by the letter "A" and suffix detail "-111."

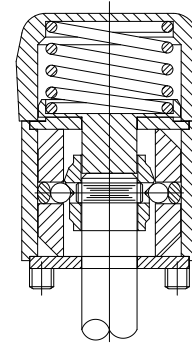

Pilot

Pilot-Two Detent Cap Assembly CA-4302-64-150

For 1/8" Thru 1/2" Valves
CA-4702-64-150

For 3/4" & 1" Valves

This Cap Assembly is denoted in the prefix letters of the valve product no. by the letter "A" and suffix detail "-150."

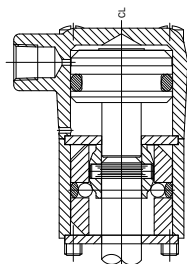

Diaphragm-Two Detent Cap Assembly CA-4302-87-208

For 1/8" Thru 1/2" Valves
CA-4702-87-208

For 3/4" & 1" Valves

This Cap Assembly is denoted in the prefix letters of the valve product no. by the letter "A" and suffix detail "-208."

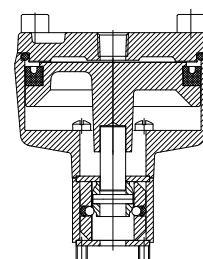

Combination Actuators

Pilot (continued)

Pilot-Spring Return (S) Cap Assembly

CA-4302-64-159

For 1/8" Thru 1/2" Valves

CA-4702-64-159

For 3/4" & 1" Valves

This Cap Assembly is denoted in the prefix letters of the valve product no. by the letter "A" and suffix detail "-159."

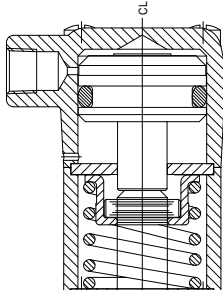

Diaphragm-Spring Return (S) Cap Assembly

CA-4302-87-160

For 1/8" Thru 1/2" Valves

CA-4702-87-160

For 3/4" & 1" Valves

This Cap Assembly is denoted in the prefix letters of the valve product no. by the letter "A" and suffix detail "-160."

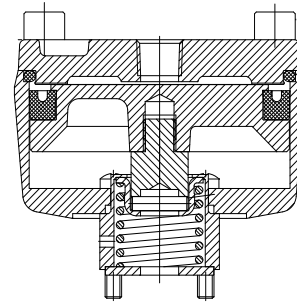

* Pilot-Push/Pull Cap Assembly

CA-4302-64-4000P

For 1/8" Thru 1/2" Valves

This Cap Assembly is denoted in the prefix letters of the valve product no. by the letter "A" and suffix detail "-4000P."

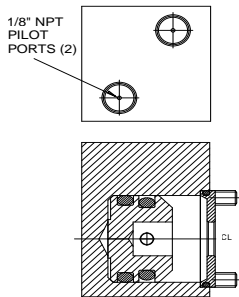

Pilot-Cam Cap Assembly

CA-4302-64-2182

For 1/8" Thru 1/2" Valves

This Cap Assembly is denoted in the prefix letters of the valve product no. by the letter "A" and suffix detail "-2182."

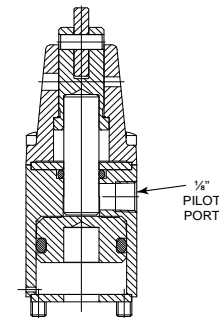

Solenoid/Pilot

Solenoid/Pilot-2 Detent Cap Assembly

CA-4302-84-173 (EXPilot)

CA-4322-84-173 (INPilot)

For 1/8" Thru 1/2" Valves

CA-4702-84-173 (EXPilot)

CA-4722-84-173 (INPilot)

For 3/4" & 1" Valves

This Cap Assembly is denoted in the prefix letters of the valve product no. by the letter "A" and suffix detail "-173."

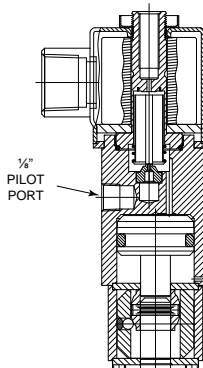

Solenoid/Pilot-Spring Return (S) Cap Assembly

CA-4302-84-138 (EXPilot)

CA-4322-84-138 (INPilot)

For 1/8" Thru 1/2" Valves

CA-4702-84-138 (EXPilot)

CA-4722-84-138 (INPilot)

For 3/4" & 1" Valves

This Cap Assembly is denoted in the prefix letters of the valve product no. by the letter "A" and suffix detail "-138."

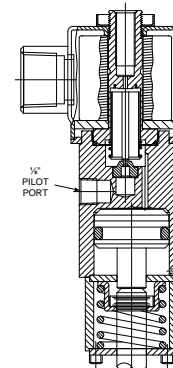

VERSA Lockout Valves

FOUR LOCKING-POST LOCKOUT VALVE

Three-Way, Palm Button Actuated, 1/8, 1/4, 3/8, 1/2, 3/4, 1, 1 1/4" NPT or G Sideported Or Subplate Mounting Styles

EXAMPLES



Sideported LOV* valve



Subplate mounted LOV* valve



Panel mounted LOV* valve

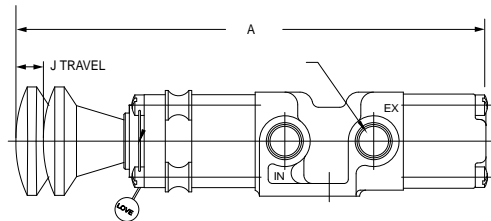
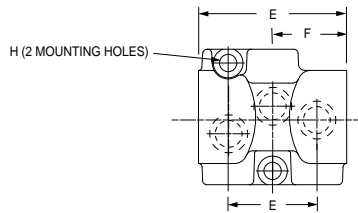
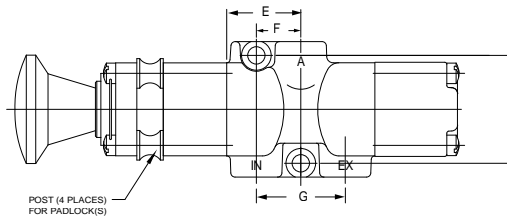
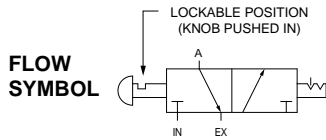

Valve	DIMENSIONS		
	1/8" & 1/4"	3/8" & 1/2"	3/4", 1", & 1 1/4"
A	7.03 (179)	8.59 (218)	11.88 (302)
B	2.00 (51)	2.75 (70)	3.75 (95)
C	1.63 (41)	1.69 (43)	2.44 (62)
D	1.59 (40.4)	2.25 (57.2)	3.13 (79.4)
E	1.09 (27.8)	1.88 (47.8)	2.75 (70)
F	0.66 (16.8)	1.00 (25.4)	1.50 (38.1)
G	1.31 (33.3)	2.00 (50.8)	3.00 (76.2)
H	0.26 (7)	0.33 (8.4)	0.39 (10)
J	0.50 (13)	0.50 (13)	0.63 (16)

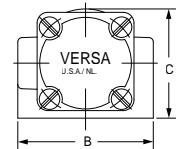

Operating Pressure Range:
0 to 200 psig (14 bar)

Construction:
Mainly forged & machined brass, plated steel screws, NBR (nitrile) seals. Aluminum subplates when required. Bright red knob and gold body make valve singularly identifiable.

Lock Requirement:
Up to four padlocks with 1/4" (6.4mm) min to 3/8" (9.5mm) max diameter shackle, or up to four hasps with 1/4" (6.4mm) min to 3/8" (9.5mm) max diameter shackle to which several locks each may be attached. Color coded indicator shows red when inlet is connected to outlet (A), blue when connected to exhaust.

Lockout & Exhaust Valves (LOVB) - Lock in exhausting position only. Meets OSHA requirements.

PRODUCT NUMBER						
Sideported			Subplate Mounted ³			
Valve	Port Size (NPT [†])	C _v	Valve	Subplate	(NPT [†])	C _v
VIZ-3201-LOVB ^{1, 2}	1/8"	1.4	VIZ-3311-LOVB ^{1, 2}	M-320-A-42L	1/8"	1.3
VIZ-3301-LOVB ^{1, 2}	1/4"	1.8		M-330-A-42L	1/4"	1.7
VIZ-3401-LOVB ^{1, 2}	3/8"	3.4		M-330-A0-42L	3/8"	1.8
VIZ-3501-LOVB ^{1, 2}	1/2"	4	VIZ-3511-LOVB ^{1, 2}	M-340-A-42L	3/8"	3.2
VIZ-3601-LOVB ^{1, 2}	3/4"	9.7		M-350-A-42L	1/2"	3.8
VIZ-3701-LOVB ^{1, 2}	1"	11.1		M-350-A0-42L	3/4"	4
			VIZ-3711-LOVB ^{1, 2}	M-360-A-42L	3/4"	9.2
				M-370-A-42L	1"	10.5
				M-370-A0-42L	1 1/4"	11.1

¹ For valves that can be locked in pressurizing or exhausting position substitute - LOVE. This option does not meet OSHA requirements for a LOCKOUT valve because it can be locked in pressurizing position. Example VIZ-3301-LOVE.

² For a valve with panel-mounting thread and nut, add - P, for example: VIZ-3301-LOVB-P, or VIZ-3301-LOVE-P.

³ All LOV* subplates have locating pins to prevent incorrect installation of valve.
[†] For corresponding G threads, add suffix -2B in product number. 1/8" to 1/2" G (sideported valve) 1/8" to 1 1/4" G (subplate). Consult factory for availability.

VERSA SPECIAL PURPOSE DUAL SOLENOID VALVES

Push Pull Solenoid Suffix -PPG

General Description

A dual solenoid valve with a hand lever. The design concept is to provide the functionality of a, dual coil, 2-position valve with the addition of manual control or any other actuator. The valve operates as standard 2-position requiring only momentary electrical contact to shift valve. Various manual actuators are available. The lever shown is a "L" type which can be manually set in either offset position when the solenoid valve is de-energized.



Redundant Solenoid 2oo2, Suffix -RS

General Description

When parallel electronic control circuits are utilized in a system, if a complete control circuit fails or requires maintenance, the parallel circuit will keep the system running. In a parallel circuit Versa's Redundant Valve functions the same as a solenoid operated-spring return valve, except that it has two solenoids (one for each of the parallel circuits) rather than one solenoid. Either or both of these solenoids will shift and maintain the controlled device in the shifted position. Both solenoids must be de-energized to return the controlled device to the un-shifted position. The use of one Redundant Valve can replace multiple valves and components to accomplish the same function. This function can be considered as a (2oo2).



Shut off Valve 1oo2, Suffix -SOV

General Description

While the *Shut off Valve* looks similar to the *Redundant Solenoid Valve* (shown above) the internal pilot circuit is different. The -SOV option provides a series pilot control circuit that requires both coils, a primary and a secondary, to be energized in order for the valve to shift. Conversely if the electrical signal to either coil is removed the valve will return to the de-energized position. This function can be considered as a (1oo2). Where various control devices (e.g., temperature, pressure switches) could be wired in series with each coil. The actuation of any one of these devices, attached to either coil, would interrupt the signal to the coil and cause the valve to shift to the de-energized position.

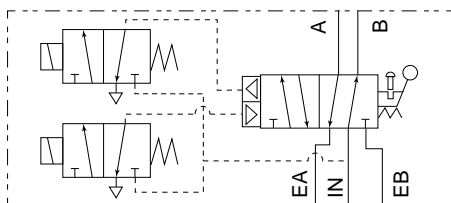

-PPG Flow Schematic

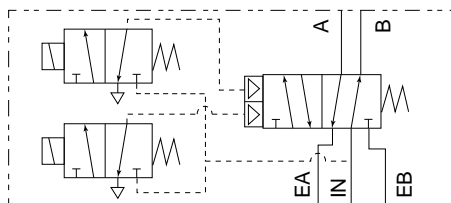

-RS Flow Schematic

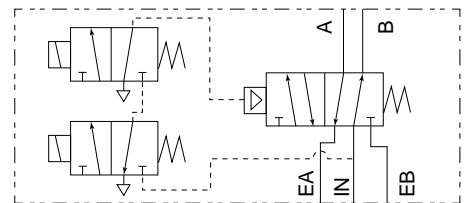

-SOV Flow Schematic

VERSA SPECIAL PURPOSE DUAL SOLENOID VALVES

How to specify SPECIAL PURPOSE DUAL SOLENOID VALVES

V SA - 3 5 2 1 - 316 - RS (OPTIONS)

V = V Series brass

LA = -PPG with Lever
IA = -PPG with Button
AA = -PPG with Latch, see page 68

SA = -RS -SOV with Spring Return
AA = -RS -SOV with Latch, see page 68

3 = Three-way
4 = Four-way

2 = 1/8"NPT (Series V**)
3 = 1/4"NPT (Series V**) or V316
4 = 3/8"NPT (Series V) or V316
5 = 1/2"NPT (Series V) or V316

2 = Threaded sideports-INPilot solenoid: no auxiliary pilot required.

1 = 3-way NC
2 = 3-way NO, 4-way/2-position
3 = 4-way/3-position (blocked center)
4 = 4-way/3-position (exhaust ports open in center)

Add "316" for stainless steel valves. Leave blank for brass

SPECIAL PURPOSE DUAL SOLENOID VALVES SUFFIX
-RS
-SOV
-PPG

OPTIONS (Refer to pages 9 to 11 for specific certifications, standards & classifications, approvals, protective codes and voltage codes.)

** Valves with ISO 228 "G" Threads are designated by utilizing suffix "-2B" in model number.

Installation, Filtration And Lubrication Valves have no limitations on mounting orientation. 40 to 50 micron filtration and general purpose lubricating oil ISO, ASTM viscosity grade 32 recommended. Ambient temperature range -10°F (-23°C) to 200°F (95°C).

Dimensions

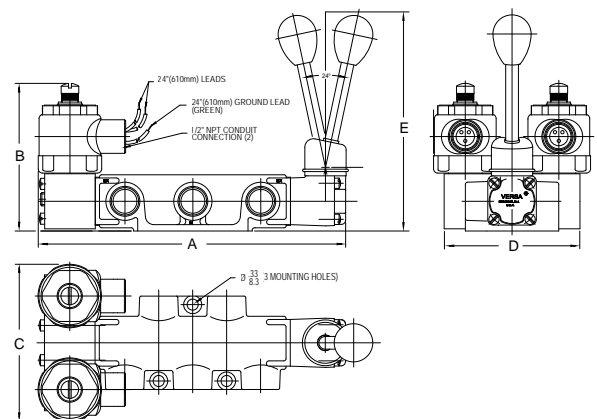
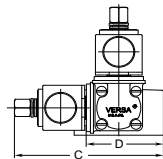
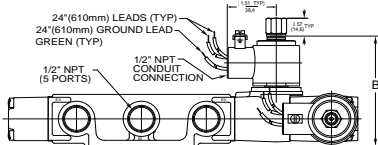
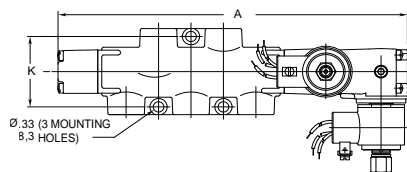

		SIZE		A	B ¹	C ¹	D
R S or S O V	3	1/8 & 1/4	in	8.8	3.52	3.66	2
	W		mm	224	89	93	51
	A	3/8 & 1/2	in	8.77	3.52	3.17	2.75
	Y		mm	223	89	80	70
S O V	4	1/8 & 1/4	in	8.50	3.52	3.66	2
	W		mm	216	89	93	51
	A	3/8 & 1/2	in	10.77	3.52	4.59	2.75
	Y		mm	273	89	117	70

		SIZE	A	B ¹	C ¹	D	E
P P G	3	1/8 &	5.49	4.35	4.62	4.0	6.37
	W	1/4	139	110	117.4	101	162
	A	3/8 &	7.05	4.35	4.62	4.0	6.45
	Y	1/2	179	110	117.4	101	163.9
	4	1/8 &	6.81	4.35	4.62	4.0	6.37
	W	1/4	173	110	117.4	101	161.9
	A	3/8 &	9.05	4.35	4.62	4.0	6.45
	Y	1/2	230	110	117.4	101	163.9

¹ Dimensions listed are for -XX type hazardous service solenoids. For dimensions with other hazardous service solenoids that can be applied, consult factory. Dimensions for standard non-hazardous service solenoids will be slightly less than those listed.

VERSA LATCHING/MANUAL RESET VALVES

Latching valves are particularly suited to applications where it is desirable or mandatory to manually reset or restart a system. A typical application could involve the emergency shutdown of automatically monitored process operations. Loss or interruption of the control signal to the valve actuator causes the valve to shift, latch and shut-down a process step. When the signal is restored the valve remains in the latched position until the operator manually unlatches it and allows the process step to resume. Positive latching in such an application is vitally important since many process operations are sequential and one step must not be started until the one ahead of it has started.

This example is only one of many which can be accommodated through the use of Versa's Latching Valves. A wide range of functional types, port sizes, actuators, and latching arrangements provide the engineer with a complete choice of valving to suit his particular needs.

The Latching Device actuator consists integral spring for returning the valve plunger, and an inline hand operator where needed to manually shift the valve. The specific Latching Device may be attached to any Series "V" valve body size or style up to 1". Typically the actuator on the opposite end of the valve body would be an automatic type such as a solenoid, a remote pressure pilot, or a low pressure diaphragm actuator.

Latching/Manual Reset Three-Way Valve,
Manifold Mounted, Solenoid Actuated.
(VAG-3521-181D-XX-D024 shown above)

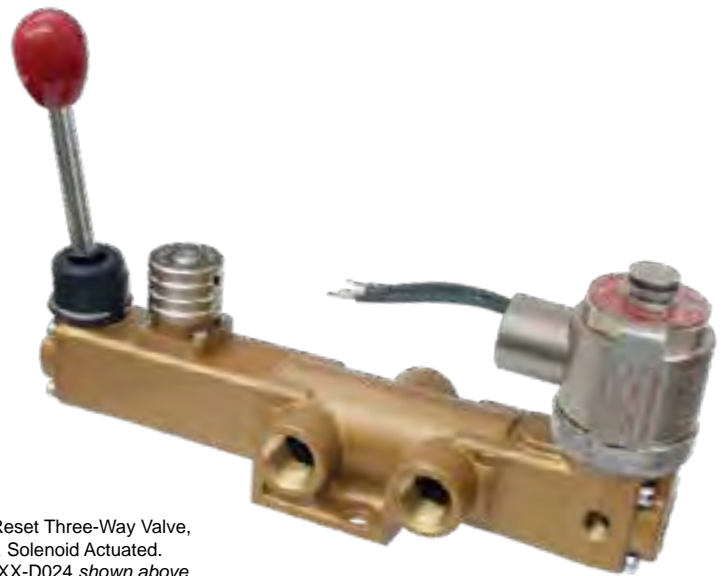

LATCHES IN ACTUATED POSITION

Series V, Suffix"-181B"

Latches automatically when plunger shifts on signal. Unlatching allows plunger to be returned by hand.

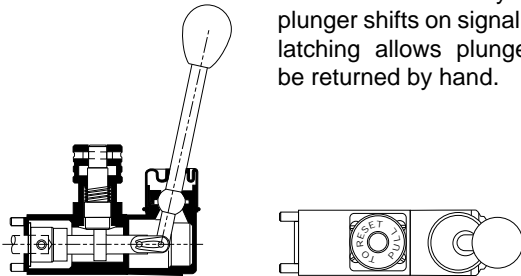

Series V, Suffix"-181C"

Latches automatically when plunger shifts on signal. Unlatching allows spring to reset plunger automatically. Hand lever provided for manual operation. (If hand lever is not required see suffix -3358A below.)

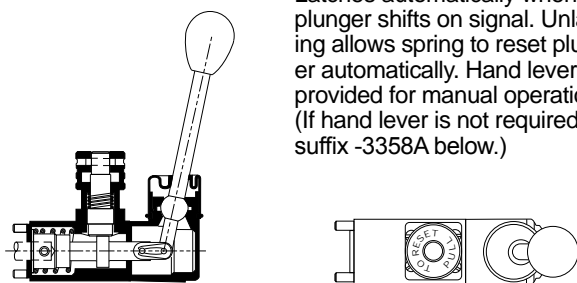

Series V, Suffix"-3358A"

Latches automatically when plunger shifts on signal. Unlatching allows spring to reset plunger automatically. (If hand lever is required for manual actuation see suffix -181C above.)

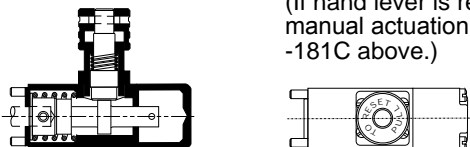

LATCHES IN UNACTUATED POSITION

Series V, Suffix"-181D"

Unlatching allows plunger to shift on signal. If signal is lost, spring shifts plunger automatically and valve latches. When signal is restored, plunger will not shift until manually unlatched. Hand lever is provided for manual operation. (If hand lever is not required see suffix -3358 below.)

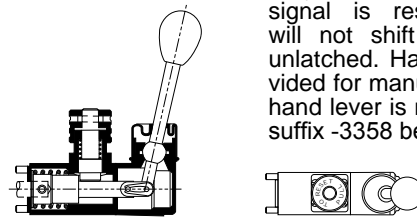

Series V, Suffix"-3358"

Unlatching allows plunger to shift on signal. Spring returns plunger automatically and valve latches. (If hand lever is required for manual actuation see suffix -181D above.)

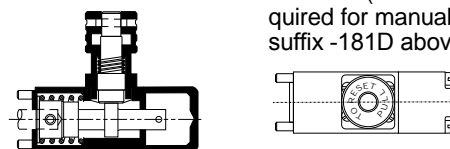

LATCHES IN EITHER POSITION

Series V, Suffix"-181AA"

(2 position latch) Valve may be manually latched in either offset position or left unlatched. Acts as spring return valve when not latched. Hand lever is provided for manual operation..

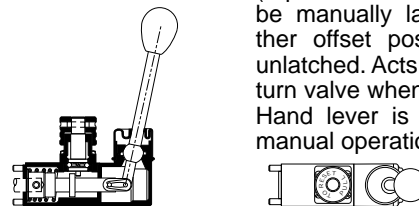

Series V, Suffix"-181J"

(3 position latch) Valve may be latched in either offset position or in center position. Acts as spring return valve when not latched. Hand lever is provided for manual operation.

LATCHING/RESET VALVES

How to specify SERIES V VALVES

V AG - 3 5 2 1 - 181B - (OPTIONS)

V = Pneumatic service: vacuum to 200 psi (14 bar)

AG = Solenoid/pilot operated (NEMA 1,2,3)
 (2NC, 3NC, 4-way, 5-way, Selector, Diverter)
 AP = Remote pressure pilot operated
 (2NC, 3NC, 4-way, 5-way, Selector, Diverter)
 AW = Diaphragm (low pressure) pilot operated
 (2NC, 3NC, 4-way, 5-way, Selector, Diverter)
 GA = Solenoid/pilot operated (NEMA 1,2,3)
 (2NO, 3NO, Selector, Diverter)
 PA = Remote pressure pilot operated
 (2NO, 3NO, Selector, Diverter)
 WA = Diaphragm (low pressure) pilot operated
 2NO, 3NO, Selector, Diverter)

2 = Two-way
 3 = Three-way
 4 = Four-way
 5 = Five-way
 7 = Diverter (one inlet-two outlets)
 8 = Selector (two inlets-one outlet)

2 = 1/8" NPT*
 3 = 1/4" NPT*
 4 = 3/8" NPT*
 5 = 1/2" NPT*
 6 = 3/4" NPT
 7 = 1" NPT

*For corresponding G thread, also use suffix -2B as option

0 = Threaded side ports - For all type actuators:
 For controlling vacuum to 200 psi (14 bar) air and where controlled medium or source is different than pilot medium or source. Solenoid/pilot or remote pressure pilot requires aux pilot pressure 55-175 psi (3.8-12 bar) air. Diaphragm pilot requires aux pilot pressure 15-50 psi (1-3.4 bar) air.
 1 = Subplate mounted ports - For all type actuators:
 For controlling vacuum to 200 psi (14 bar) air and where controlled medium or source is different than pilot medium or source. Solenoid/pilot or remote pressure pilot requires aux pilot pressure 55-175 psi (3.8-12 bar) air. Diaphragm pilot requires aux pilot pressure 15-50 psi (1-3.4 bar) air.
 2 = Threaded side ports - INPilot solenoid only:
 For controlling pressures 55-175 psi (3.8-12 bar) air. No auxiliary pilot required.
 3 = Subplate mounted ports - INPilot solenoid only:
 For controlling pressures 55-175 psi (3.8-12 bar) air. No auxiliary pilot required.

1= 2NC, 3NC
 2= 2NO, 3NO, 4-way two position, 5-way two position, Selector, Diverter
 3= Three-position, 3, 4, 5-way, Selector, Diverter, -all ports closed in center position.
 4= Three-position, 3, 4-way, — exhaust ports open in center position.

-181AA
 -181B
 -181C Locking/reset device
 -181D (refer to page 68 for specific device required)
 -181J
 -3358
 -3358A

OPTIONS

-XX = Solenoid operator for hazardous service (NEMA 7 & 9);
 Class I, Division 2 (A & B); Class I, Division 1 (C & D);
 Class II, Division 1 (E, F & G).
 -3567 = Low watt (1.8W) solenoid operator for hazardous service (NEMA 7 & 9)
 Max operating pressure 120 PSI (8.3 bar)

Consult factory for specific certifications, standards & classifications, approvals, and protective codes.

VERSA Series V “Oil-Free Service” Valves

- Ideal for permanently lubricated cylinders · Needs no airline lubricator*
- Helps in meeting OSHA requirements

WHEN TO USE THEM

Whenever oil or lubricators cause problems:

- In vacuum service
- Where air flow is too low due to small cylinders or infrequent cycling
- Where lubricator cannot be properly positioned
- In food and beverage plants

In food applications, specify suffix “-55A” ...for valve prelubricated with an FDA approved grease.

*Like any moving device, a valve lasts longer with lubrication. (Refer to Page 7 for lubricant recommendations). Use “Oil-Free Service” valves only when necessary. Filtration is always recommended.

HOW TO SPECIFY “OIL-FREE SERVICE” VALVES

I. IF THE REQUIRED VALVE IS:

- Three-Way-normally closed or Four-Way, AND it is
- Single solenoid (VSG) INPilot or single pressure pilot (VSP) actuated, AND it is
- Spring return, AND it
- Does not require the Dustproof option (-D or -DD) then
- Specify by adding suffix -3530S to the product number.

II. IF THE REQUIRED VALVE IS:

- Other than described in I. (at left), then
- Specify by adding suffix-3530 to the product number.

BE SURE TO OBSERVE THE PRESSURE LIMITATIONS LISTED FOR THE SPECIFIC SUFFIX DETAIL SELECTED.

SUFFIX-3530S

Series “V” Valve — Single Solenoid (VSG-INPilot) or Single Pressure Pilot (VSP) operated, without dustproof option. For others specify -3530.

1/8” thru 1/2” NPT or G

3NC or 4-way

Suffix-3530S includes SELECTAIRE® Air Assisted spring. It combines spring force, constantly applied, with a pilot assist, automatically applied on return only.

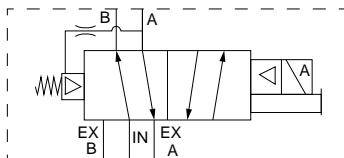

Consult factory before using cylinder speed controls on SELECTAIRE® (Air Assisted) spring return equipped valves in high-cycle-rate applications.

OPERATING PRESSURE RANGE FOR SUFFIX -3530S

VSP: 60 psi (4 bar) ± 10% to 200 psi (14 bar)
 VSG-(INPilot): 60 psi (4 bar) ± 10% to 175 psi (12 bar)

SUFFIX-3530

Series “V” Valve — other than those listed for suffix-3530S

1/8” thru 1” NPT and 1/8 thru 1/2 G

2, 3, 4 or 5-way, selector, or diverter

OPERATING PRESSURE RANGE FOR SUFFIX -3530

ACTUATION	RETURN	CONTROLLED PRESSURE	MINIMUM AUX. PILOT PRESSURE REQUIRED
Manual or Mechanical	Spring or Spring Centering	Vacuum to 200 psi (14 bar)	N/A
Pressure Pilot or Solenoid pilot (EXPilot)	Spring or Spring Centering	Vacuum to 200 psi (14 bar)	60 psi (4 bar) ± 10%
Pressure Pilot or Solenoid pilot (EXPilot)	Pressure Pilot or Solenoid pilot (EXPilot)	Vacuum to 200 psi (14 bar)	30 psi (2 bar) ± 10%
Solenoid pilot (INPilot)	Spring or Spring Centering	60 psi (4 bar) ± 10% to 175 psi (12 bar)	N/A
Solenoid pilot (INPilot)	Solenoid pilot (INPilot)	30 psi (2 bar) ± 10% to 175 psi (12 bar)	N/A

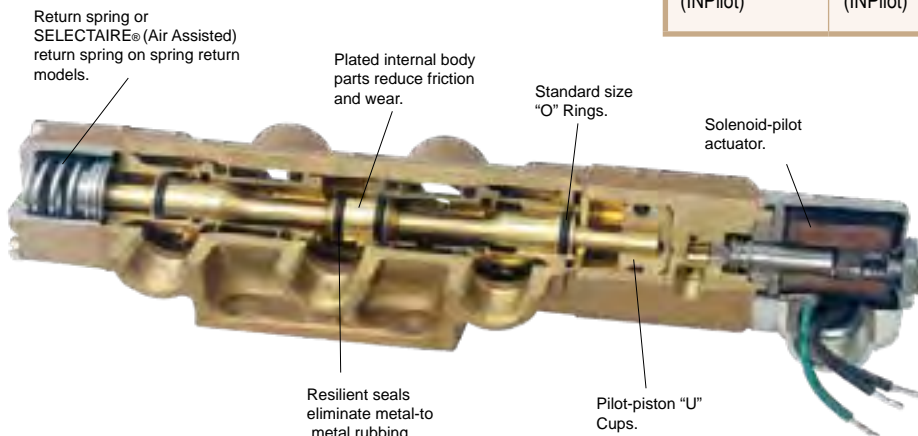

Cutaway shows side-ported “Oil-Free Service” Series “V” one of many models in the Versa line.

STAINLESS STEEL TAG

ORDERING INFORMATION

Order any B-316, C-316, T, V or V-316 valve. As a separate line item (listed directly under valve part number to be tagged) list the tag part number P-2002-16-NV28A. In remarks field specify the tag marking instructions. If sequential numbering is required provide the start and end numbers required in the sequence for the appropriate number of valves.



Engraving Options

Versa's engraved tags are available in two configurations.

Configuration one: is a simple text field consisting of two lines of text, 20 characters maximum per line. The text can be specified as alpha, numeric or both.

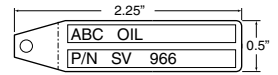

Configuration two: is a text field with sequential numbering added. This option includes two lines of text. Line one is text. Line two allows for sequentially numbering the tag, 20 characters maximum per line.

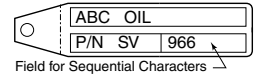

REPAIR KITS

The Repair Kits listed below contain all the parts necessary to restore a valve to prime operating condition. Because these are universal kits, some parts may not require use in all valves.

Where applicable, solenoid operator parts, not including coils, are also included. Coils may be ordered separately, See heading **Coils** at the bottom of this page.

VALVE SIZE	FOR ALL SERIES V VALVES				
	Hand, Foot, Cam, Pilot Actuated Valves	Solenoid/Pilot Actuated Valves (Nonhazardous Service)*		Diaphragm Actuated Valves	
		2-Position Single Solenoid	2 & 3-Position Double Solenoid	2-Position	2 & 3-Position
1/8 & 1/4	V-4332	V-4332-G	V-4332-GG	V-4302-W-31	V-4302-WW-31
3/8 & 1/2	V-4532	V-4532-G	V-4532-GG	V-4502-W-31	V-4502-WW-31
3/4 & 1	V-4732	V-4732-G	V-4732-GG	V-4702-W-31**	V-4702-WW-31**
1-1/4	V-4732-12	V-4732-12-G	V-4732-12-GG	—	—

*For Hazardous Service Valves, consult factory. **For Diaphragm valves without option 31 use V-4702-W and V-4702-WW respectively.

Seal Material Options

The following seal materials can be specified as an option. Indicate by placing the Suffix Option designation after the appropriate product number shown above.

For example: V-4332 [standard NBR (nitrile) seals] becomes V-4332-155 (fluorocarbon seals).

Suffix Option

- EP EPR (ethylene propylene) elastomeric seals for phosphate ester type hydraulic fluids, acids, weak caustics, methyl ethyl ketone, silicone greases and oils. Consult factory for other uses. Not for petroleum base fluids or lubricants, or hydrocarbon solvents.
- 11 NBR (high nitrile) seals for petroleum base and silicate ester hydraulic fluids, high and low aniline lubricating oils, "sweet" natural gas, ammonia. Static and dynamic seals, except for piston seal, are furnished in special compound. Piston seal is standard.
- 155 FKM (fluorocarbon) elastomeric seals

Solenoid Plunger

One size solenoid plunger fits all Series V or T valves regardless of valve size. Exceptions to this are valves for hazardous service. Consult factory for these items. Solenoid plungers are included in the Universal Repair Kits for solenoid valves. However, should you require only the solenoid plunger you may order same by using the following part number:

- P-1002-08** Standard NBR (nitrile) seal
- P-1002-08-3** FKM (fluorocarbon) seal (Suffix Option -3 & -155)
- P-1002-08-11** NBR (high nitrile) seal (Suffix Option -11)
- P-1002-08-EP** EPR (ethylene propylene) seal (Suffix Option -EP)

Coils

One size coil fits all Series V or T valves regardless of valve size. Exceptions to this are valves with suffix options -HC, -P, -PC, -PS & valves for hazardous service. Consult factory for these items. To specify a coil as a single part use the following part number:

P-1002-02-(Coil Code from Page 9).

For example, to indicate a standard 120v60 coil, the part number would be P-1002-02-A120.

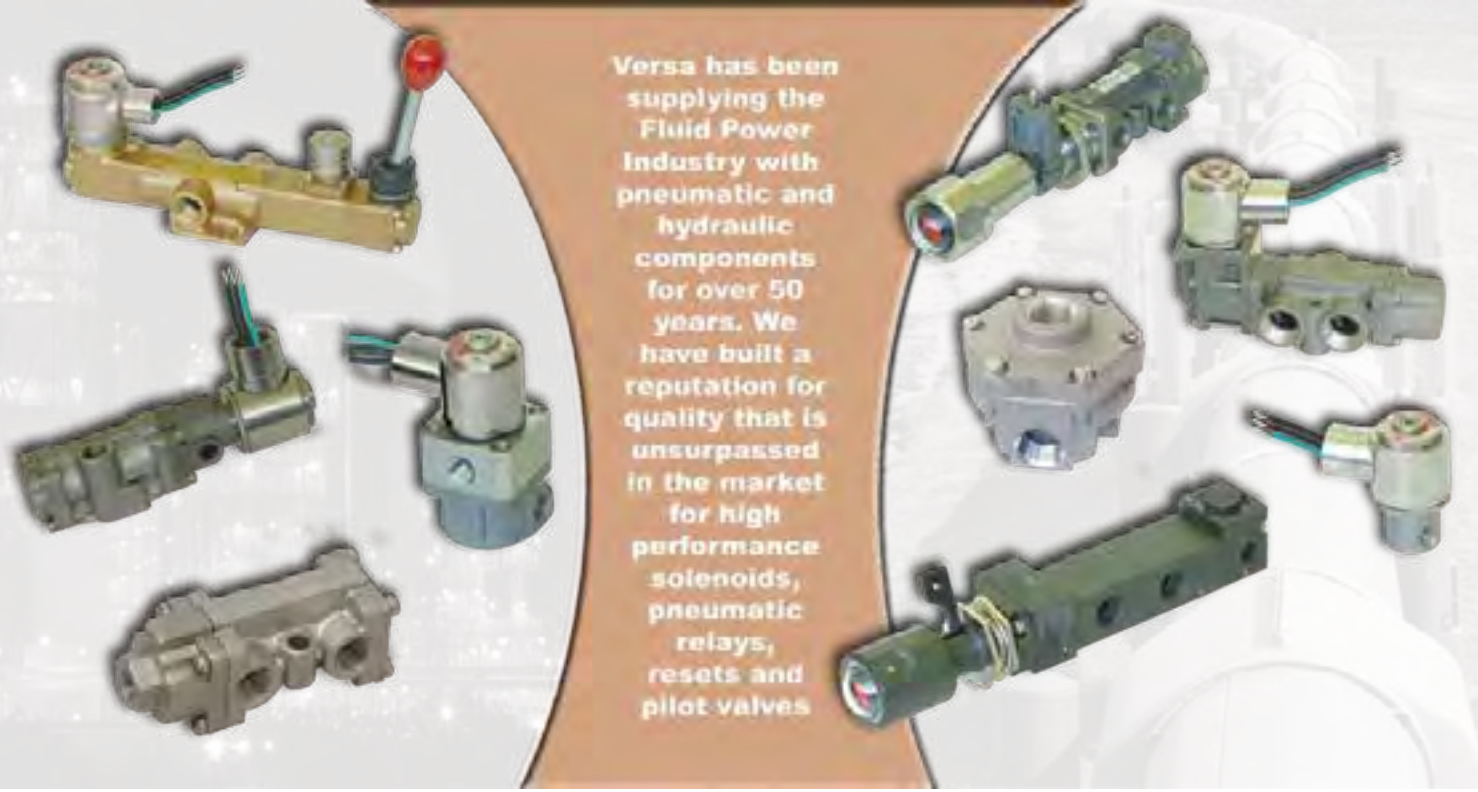

Versa has been supplying the Fluid Power Industry with pneumatic and hydraulic components for over 50 years. We have built a reputation for quality that is unsurpassed in the market for high performance solenoids, pneumatic relays, resets and pilot valves

WARNINGS REGARDING THE DESIGN APPLICATION, INSTALLATION AND SERVICE OF VERSA PRODUCTS

The warnings below must be read and reviewed before designing a system utilizing, installing, servicing, or removing a Versa product. Improper use, installation or servicing of a Versa product could create a hazard to personnel and property.

DESIGN APPLICATION WARNINGS

Versa products are intended for use where compressed air or industrial hydraulic fluids are present. For use with media other than specified or for non-industrial applications or other applications not within published specifications, consult Versa.

Versa products are not inherently dangerous. They are only a component of a larger system. The system in which a Versa product is used must include adequate safeguards to prevent injury or damage in the event of system or product failure, whether this failure be of switches, regulators, cylinders, valves or any other system component. System designers must provide adequate warnings for each system in which a Versa product is utilized. These warnings, including those set forth herein, should be provided by the designer to those who will come in contact with the system.

Where questions exist regarding the applicability of a Versa product to a given use, inquiries should be addressed directly to the manufacturer. Confirmation should be obtained directly from the manufacturer regarding any questioned application prior to proceeding.

INSTALLATION, OPERATION AND SERVICE WARNINGS

Do not install or service any Versa product on a system or machine without first depressurizing the system and turning off any air, fluid, or electricity to the system or machine. All applicable electrical, mechanical, and safety codes, as well as applicable governmental regulations and laws must be complied with when installing or servicing a Versa product.

Versa products should only be installed or serviced by qualified, knowledgeable personnel who understand how these specific products are to be installed and operated. The individual must be familiar with the particular specifications, including specifications for temperature, pressure, lubrication, environment and filtration for the Versa product which is being installed or serviced. Specifications may be obtained upon request directly from Versa. If damages should occur to a Versa product, do not Operate the system containing the Versa product. Consult Versa for technical information.

LIMITED WARRANTY DISCLAIMER AND LIMITATION OF REMEDIES
 Versa's Series products are warranted to be free from defective material and workmanship for a period of ten years from the date of manufacture, provided said products are used in accordance with Versa specifications. Versa's liability pursuant to that warranty is limited to the replacement of the Versa product proved to be defective provided the allegedly defective product is returned to Versa or its authorized distributor. Versa provides no other warranties, expressed or implied, except as stated above. There are no implied warranties of merchantability or fitness for a particular purpose. Versa's liability for breach of warranty as herein stated is the only and exclusive remedy and in no event shall Versa be responsible or liable for incidental or consequential damages.

Versa Products Company Inc.
 22 Spring Valley Road
 Paramus, New Jersey 07652
 USA
 Phone: (201) 843-2400
 Fax: (201) 843-2931

Versa BV
 Prins Willem Alexanderlaan
 1427
 7321 GB Apeldoorn
 The Netherlands
 Phone: +31-55-368-1900
 Fax: +31-55-368-1909



www.versa-valves.com
 email: sales@versa-valves.com